

# SUPER KORRIGAN - 1149B

COMPACT - 1200 W HMI

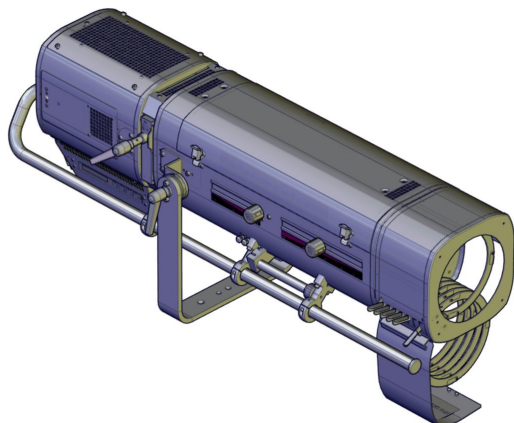

- **Type:** Followspot
- **Source:** 1200 W HMI
- **PSU:** Magnetic - hot restrike
- **Optics:** 7° to 14,5° zoom
- **DMX-control of motorised dimmer shutter**

Followspot

## High output with DMX dimming control

The award-winning long throw Super Korrigan out-performs Xenon spots of higher wattage. Widely used in theatres where high output, instantaneous re-ignition, silent operation and compact dimensions are key. DMX dimming control enables perfect synchronisation of fades and blackouts.

### Features

- **Fully closing iris cassette:** removable for fast, easy replacement; protective backplate for extended lifespan
- **Universal adjustable gobo holder:** a-size glass and metal gobos
- **Ergonomic dimmer control:** one-handed dim, pan and tilt
- **Smooth dimmer shutter:** retains flat beam and colour temperature when dimming
- **Remote DMX-control:** DMX-control of motorised dimmer shutter - effects synchronising remotely with pinpoint accuracy. Control from both local and DMX through 'Master' function
- **Frost filter:** on flip lever for quick soft-edge beam effect
- **Horizontal chopper (optional):** for masking control in TV studios and wide stages
- **Internal glass filter holder:** long term use of durable coloured, dichroic or textured glass
- **Individually removable colour frame:** gels replaced easily while colour cassette remains in place
- **Colour changer:** 6-way, self-cancelling boomerang colour-changer
- **Scroller:** standard scroller colour changer can be installed and powered from the unit through built-in XLR (24V+DMX) output connector
- **RJ NET:** ensures optimum operation capacities, providing a wide pallet of feedback information (dimming level, lamp hours, projector status...) on integrated LCD display
- **Easy focus reference:** graduated scale on side of lantern; fast and easy refocusing
- **Adjustable yoke (optional):** for optimum overhead positioning
- **Fine balance:** precision positioning and smooth operation even with the smallest movements
- **Stand:** perfectly weighted for maximum stability with smooth rotation for optimum performance. Easy set up; triple safety system for extra security

### Optical

- **Factory set optical train:** travels safely within followspot and requires no time-consuming realignment on arrival. Uniform beam on all followspots of same type
- **SX optical system:** double condenser optics for exceptional optical quality
- **Gobo :** excellent gobo projection
- **Variable zoom optics:** sharp focus at every beam angle

### Construction

- **Made in France :** fully manufactured in Robert Juliat premises retaining complete control over all aspects of quality
- **Separate PSU:** compact for easy handling and rapid maintenance
- **Bodywork:** strong sheet metal construction for durability
- **Ergonomic wrap-around handle:** comfort, safety and practicality from all operating positions
- **Moving parts:** smooth at all times, even when hot
- **Captive knobs and handles:** additional security when working at height or in transit
- **Easy access to all parts:** easy cleaning, re-lamping and maintenance
- **Removable assemblies:** fast-plug cable connectors and complete component assemblies (mirror, condenser set and lamp house assembly) save maintenance and cleaning time
- **Safety:** safety switch for secure access to the lamp

Picture:1149B

DSEN098\_1149B - 18/05/2017

Robert Juliat reserves the right to change or alter any of the items detailed on this page, to increase or improve manufacturing techniques without prior notice.

Robert Juliat S.A.S., 32 rue de Beaumont, 60530 Fresnoy-en-Thelle - France  
Telephone : +33 (0)3 44 26 51 89 - fax : +33 (0)3 44 26 90 79 - info@robertjuliat.fr  
www.robertjuliat.com



ROBERT JULIAT

## Source



- **Lamp type:** Discharge
- **Power:** 1200 W
- **Socket:** SFC 15.5-6
- **Hot re-strike:** yes

Admissible lamps	Power *	Lumen output*	Colour temperature*	Life*	CRI* (min)
CSR 1200W DE (GE )	1 200 W	110 000 lm	6000K	750 h	>85
HMI 1200W/DXS (Osram )	1 200 W	110 000 lm	6000K	1 000 h	>90
MSI 1200 (Philips )	1 200 W	110 000 lm	5600K	1 000 h	80

(\*) manufacturer's data

## Optics

### Characteristics

- **Type:** Zoom
- **Beam range:** 7° to 14,5°
- **Focal length:** 283 - 589 mm

### Gel filter

- **Shape:** Circle
- **Standard size:** 210 mm (8.3 in)

### Gobo

- **Size:** A
- **Material:** Metal  
Glass



## Photometrics

with HMI 1200W/DXS (Osram ) source

### • Optics @ 7°

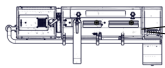

7°  
Field angle  
3%

**Beam intensity**  
1 500 000 cd

<b>Distance</b>	15 m	20 m	25 m	30 m	35 m	40 m
<b>Diameter</b>	1.8 m	2.4 m	3.1 m	3.7 m	4.3 m	4.9 m
<b>Illumination</b>	6 700 lux	3 800 lux	2 450 lux	1 700 lux	1 250 lux	940 lux
<b>Distance</b>	50 ft	65 ft	80 ft	100 ft	115 ft	130 ft
<b>Diameter</b>	6.1 ft	8 ft	9.8 ft	12.2 ft	14.1 ft	15.9 ft
<b>Illumination</b>	610 fc	360 fc	240 fc	160 fc	120 fc	90 fc

### • Optics @ 14.5°

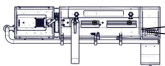

14.5°  
Field angle  
3%

**Beam intensity**  
460 000 cd

<b>Distance</b>	15 m	20 m	25 m	30 m	35 m	40 m
<b>Diameter</b>	3.8 m	5.1 m	6.4 m	7.6 m	8.9 m	10.2 m
<b>Illumination</b>	2 050 lux	1 200 lux	740 lux	520 lux	380 lux	290 lux
<b>Distance</b>	50 ft	65 ft	80 ft	100 ft	115 ft	130 ft
<b>Diameter</b>	12.7 ft	16.5 ft	20.4 ft	25.4 ft	29.3 ft	33.1 ft
<b>Illumination</b>	190 fc	110 fc	75 fc	47 fc	35 fc	28 fc

## Remote control

- **Data protocol:** USITT DMX512-A

- **Data IN connector:** 5 pins XLR male
- **Data OUT connector:** 5 pins XLR female



### • DMX chart:

#### Mode 1 (2 channels)

Mode control  
Dimmer

#### Mode 2 (3 channels)

Mode control  
Dimmer  
Dimmer fine

#### Mode 3 (3 channels)

Mode control  
Dimmer  
Dimmer master

#### Mode 4 (4 channels)

Mode control  
Dimmer  
Dimmer fine  
Dimmer master

## Dimensions and weight

### Unit

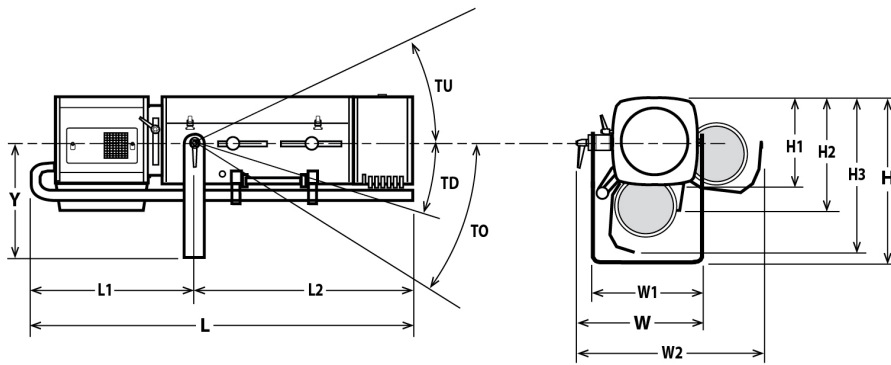

**Weight:** 36 kg (79.2 lbs)

Height	Length	Width	Yoke	Tilt	Option
H= 450 mm (17.7 in)	L= 1260 mm (49.6 in)	W= 410 mm (16.1 in)	Y= 325 mm (12.8 in)	TU= 45°	TO= TBD°
H1= 250 mm (9.8 in)	L1= 580 mm (22.8 in)	W1= 350 mm (13.8 in)		TD= 40°	
H2= 340 mm (13.4 in)	L2= 680 mm (26.8 in)	W2= 570 mm (22.4 in)			
H3= 460 mm (18.1 in)					

### Shipping

• **Weight :** 98 kg (215.6 lbs)

• **Volume :** .58 m<sup>3</sup> (20.48 ft<sup>3</sup>)

### PSU

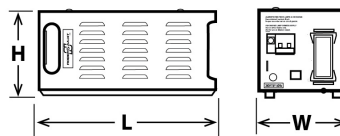

**Width:** W= 185 mm (7.3 in)

**Height:** H= 200 mm (7.9 in)

**Length:** L= 450 mm (17.7 in)

**Weight:** 24 Kg (52.8 lbs)

### Installation

• **Minimum distance to illuminated surface:** 2.8 m ( 9.2 ft )

• **Operating position:**

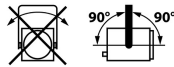

### Warranty

• **Period: 2 years**

See General Sales Condition on website

### Approvals



### Construction

- **Housing:** Steel sheet - Aluminium
- **Colour:** Black
- **Cooling:** Low noise fan
- **Maximum ambient temperature (Ta):** 40°C (104°F)
- **Maximum case temperature (Tc):** 230°C (446°F)
- **Total heat dissipation:** 5 290 BTU/h
- **Protection rating:** 20

- **PSU housing:** Steel sheet - Aluminium
- **PSU colour:** Black
- **PSU cooling:** Convection cooling
- **PSU maximum ambient temperature (Ta):** 40°C (104°F)
- **PSU maximum case temperature (Tc):** 60°C (140°F)

### Electrical compatibility

- 220/230 V - 50 Hz
- 245 V - 50 Hz
- ~~410/420 V - 60 Hz~~
- 208 V - 60 Hz
- ~~220 V - 60 Hz~~
- ~~400 V - 50 Hz~~
- ~~400 V - 60 Hz~~
- Selector: intenal

### Power input



- **Type:** attached power cord
- **Cable:** H07RNF 3G1.5
- **Length:** 3 m (9,8 ft)
- **Power connector:** CEE 7/7 (2P+E NF/Schuko)

### Power consumption

Voltage	Frequency	Current	Power	Power factor
230 V	50 Hz		1550 W	TBD
120 V	60 Hz			TBD
245 V	50 Hz			TBD

### Power Supply Unit

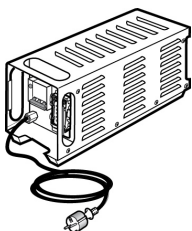





- **PSU:** Separate - Magnetic PSU
- **Lighting unit / PSU cable:** Removable cable - length: 3 m (9,8 ft)  
Type: 18G1,5 JZ 602-RC (CE-UL/CSA) with 16x16A+E Harting Han® connectors
- **Maximum distance between lighting unit and PSU:** 25 m (82 ft)
- **Control:** Local
- **Protection:** Mains: 16A 2P2D - C curve breaker / Electronic: 6A 2P2D - C curve breaker









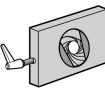

## Model





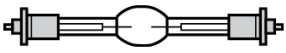





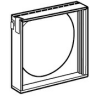

<b>1149B</b>	1200 W HMI Followspot - 1149B Super Korrigan - 7/14,5° - Magnetic PSU - DMX dimmer control
--------------	--

## Options

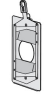
<b>PCP1716A</b>	16A blue 2P+E 6h IEC60309 power connector	
<b>FRO/1117PV</b>	Heavy duty adjustable yoke	
<b>PG80</b>	Ø80mm chopper kit (G80+ GR120+ adaptation kit)	
<b>M210TM</b>	6 ways "push/pull" colour changer	
<b>CAG/C</b>	Left side controls (Iris/Dimmer/Frost/Colour changer)	
<b>FC1459</b>	Flight-case for Compact range / GT stand / P.S.U. / accessories - Dim: 1340x710x700mm - Poids: 55 Kg	

## Accessories

<b>CCU1</b>	Full closing iris cassette - Weight: 1,33 Kg <b>1 included</b>	
<b>PF1011</b>	Ø210 mm metal filter holder <b>6 included</b>	
<b>SGUP</b>	Universal "A" size gobo-holder (metal, glass, frosted glass) <b>1 included</b>	
<b>VDM100</b>	Ø97mm frosted glass with holder <b>1 included</b>	
<b>M210B</b>	6 ways "boomerang" colour changer - Weight: 3,36 Kg <b>1 included</b>	
<b>TC1149</b>	Tool case with spare parts - Weight: 1,65 Kg <b>1 included</b>	
<b>HMI 1200W/DXS</b>	HMI 1200W/DXS - Osram SFc 15.5-6 1200W 1000h 6000K lamp	
<b>GT1000</b>	Tripod stand - SWL: 40 Kg - max. height: 1550 mm - Weight: 9,27 Kg	
<b>GT4000</b>	Tripod stand with safety chain - SWL: 130 Kg - max. height: 1030 mm - Weight: 7,91 Kg	
<b>GT4000S</b>	Tripod stand without safety chain - SWL: 130 Kg - max. height: 1030 mm - Weight: 8,65 Kg	

<b>JPP</b>	Monopod stand for overhead followspot - Weight: 3,6 Kg	
<b>T1000</b>	TV spigot with followspots swivel head - Weight: 1,82 Kg	
<b>T4000</b>	Followspot mount for Ø50mm pipe (suspension or overhead) - SWL= 100 Kg - Weight: 4,88 Kg	
<b>CAV700A</b>	Double slot front cassette for 215x215mm accessories - Weight: ,52 Kg	
<b>FCM100</b>	Ø97mm CTO correction filter (5500K → 3400K) with holder	
<b>VD120</b>	120x120mm frosted glass	
<b>FRO/1017PD</b>	Heavy duty adjustable yoke - Weight: 4,33 Kg	
<b>Kit G80</b>	Ø80mm chopper kit (G80+ GR120+ adaptation kit) - Weight: ,69 Kg	
<b>M210T</b>	6 ways "push/pull" colour changer - Weight: 3,67 Kg	
<b>M210TVCL</b>	Light shield for M210T push/pull colour changer - Weight: 1,98 Kg	
<b>Kit TELRAD</b>	Telrad followspot sight with raiser and universal mounting kit - Weight: 1,23 Kg	
<b>SDUP</b>	Followspot cue sheet holder with universal mounting kit	
<b>P1FCAN</b>	Remote controller for dimming shutters - Weight: ,44 Kg	
<b>FC1459/S</b>	Flight-case for Compact range / GT stand / P.S.U. / accessories - Weight: 55 Kg	
<b>W/GT800</b>	Set of 3 wheels for GT800/1000 stand - Weight: 2,33 Kg	