

SUPER KORRIGAN - 1149

COMPACT - 1200 W HMI



- **Type:** Followspot
- **Source:** 1200 W HMI
- **PSU:** Magnetic - hot restrike
- **Optics:** 7° to 14,5° zoom

Followspot

High output with hot restrike

The award-winning long throw Super Korrigan out-performs Xenon spots of higher wattage. Widely used in theatre environments where high output, instantaneous re-ignition and compact dimensions are a real advantage, Super Korrigan also benefits from a silent operation.

Features

- **Fully closing iris cassette:** removable for fast, easy replacement; protective backplate for extended lifespan
- **Universal adjustable gobo holder:** a-size glass and metal gobos
- **Ergonomic dimmer control:** one-handed dim, pan and tilt. Dimmer control can be adjusted to suit the operator's preference
- **Smooth dimmer shutter:** retains flat beam and colour temperature when dimming
- **Frost filter:** on flip lever for quick soft-edge beam effect
- **Horizontal chopper (optional):** for masking control in TV studios and wide stages
- **Internal glass filter holder:** long term use of durable coloured, dichroic or textured glass
- **Individually removable colour frame:** gels replaced easily while colour cassette remains in place
- **Colour changer:** 6-way, self-cancelling boomerang colour-changer
- **Easy focus reference:** graduated scale on side of lantern; fast and easy refocusing
- **Adjustable yoke (optional):** for optimum overhead positioning
- **Fine balance:** precision positioning and smooth operation even with the smallest movements
- **Stand:** perfectly weighted for maximum stability with smooth rotation for optimum performance. Easy set up; triple safety system for extra security

Optical

- **Factory set optical train:** travels safely within followspot and requires no time-consuming realignment on arrival. Uniform beam on all followspots of same type
- **SX optical system:** double condenser optics for exceptional optical quality
- **Gobo :** excellent gobo projection
- **Variable zoom optics:** sharp focus at every beam angle

Construction

- **Made in France :** fully manufactured in Robert Juliat premises retaining complete control over all aspects of quality
- **Separate PSU:** compact for easy handling and rapid maintenance
- **Bodywork:** strong sheet metal construction for durability
- **Ergonomic wrap-around handle:** comfort, safety and practicality from all operating positions
- **Moving parts:** smooth at all times, even when hot
- **Captive knobs and handles:** additional security when working at height or in transit
- **Easy access to all parts:** easy cleaning, re-lamping and maintenance
- **Removable assemblies:** fast-plug cable connectors and complete component assemblies (mirror, condenser set and lamp house assembly) save maintenance and cleaning time
- **Safety:** safety switch for secure access to the lamp

Picture:1149

DSEN103_1149 - 18/05/2017

Robert Juliat reserves the right to change or alter any of the items detailed on this page, to increase or improve manufacturing techniques without prior notice.

Robert Juliat S.A.S., 32 rue de Beaumont, 60530 Fresnoy-en-Thelle - France
Telephone : +33 (0)3 44 26 51 89 - fax : +33 (0)3 44 26 90 79 - info@robertjuliat.fr
www.robertjuliat.com



ROBERT JULIAT

Source



- **Lamp type:** Discharge
- **Power:** 1200 W
- **Socket:** SFc 15.5-6
- **Hot re-strike:** yes

Admissible lamps	Power *	Lumen output*	Colour temperature*	Life*	CRI* (min)
CSR 1200W DE (GE)	1 200 W	110 000 lm	6000K	750 h	>85
HMI 1200W/DXS (Osram)	1 200 W	110 000 lm	6000K	1 000 h	>90
MSI 1200 (Philips)	1 200 W	110 000 lm	5600K	1 000 h	80

(*) manufacturer's data

Optics

Characteristics

- **Type:** Zoom
- **Beam range:** 7° to 14,5°
- **Focal length:** 283 - 589 mm

Gel filter

- **Shape:** Circle
- **Standard size:** 210 mm (8.3 in)

Gobo

- **Size:** A
- **Material:** Metal
Glass



Photometrics

with HMI 1200W/DXS (Osram) source

• Optics @ 7°

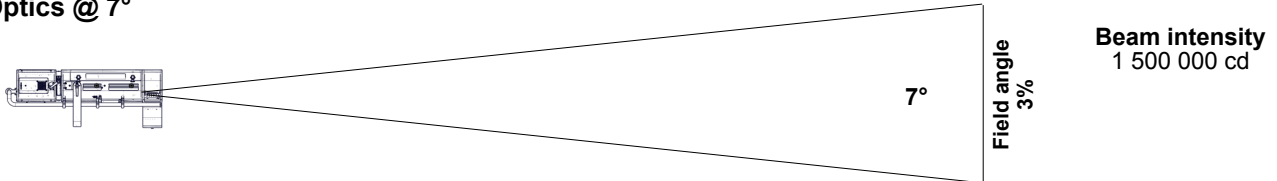

Distance	15 m	20 m	25 m	30 m	35 m	40 m
Diameter	1.8 m	2.4 m	3.1 m	3.7 m	4.3 m	4.9 m
Illumination	6 700 lux	3 800 lux	2 450 lux	1 700 lux	1 250 lux	940 lux
Distance	50 ft	65 ft	80 ft	100 ft	115 ft	130 ft
Diameter	6.1 ft	8 ft	9.8 ft	12.2 ft	14.1 ft	15.9 ft
Illumination	610 fc	360 fc	240 fc	160 fc	120 fc	90 fc

• Optics @ 14.5°

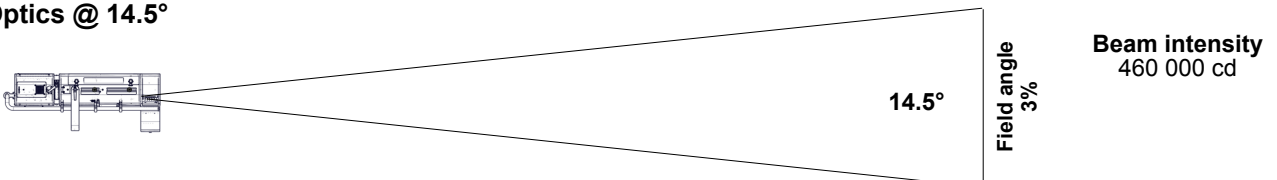

Distance	15 m	20 m	25 m	30 m	35 m	40 m
Diameter	3.8 m	5.1 m	6.4 m	7.6 m	8.9 m	10.2 m
Illumination	2 050 lux	1 200 lux	740 lux	520 lux	380 lux	290 lux
Distance	50 ft	65 ft	80 ft	100 ft	115 ft	130 ft
Diameter	12.7 ft	16.5 ft	20.4 ft	25.4 ft	29.3 ft	33.1 ft
Illumination	190 fc	110 fc	75 fc	47 fc	35 fc	28 fc

Dimensions and weight

Unit

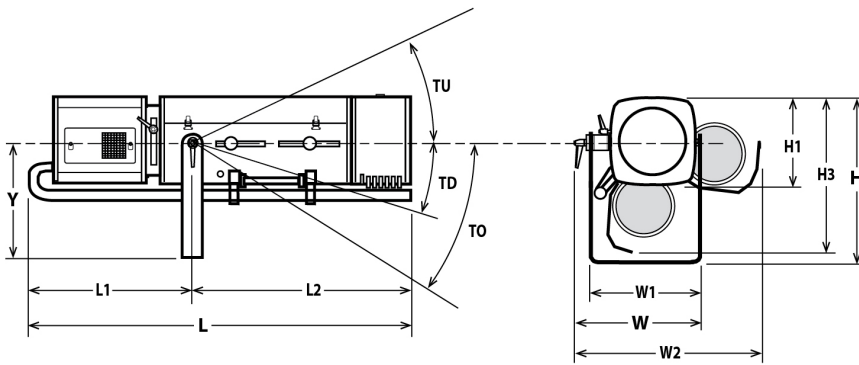

Weight: 33 kg (72.6 lbs)

Height	Length	Width	Yoke	Tilt	Option
H= 450 mm (17.7 in)	L= 1260 mm (49.6 in)	W= 410 mm (16.1 in)	Y= 325 mm (12.8 in)	TU= 45°	TO= TBD°
H1= 250 mm (9.8 in)	L1= 580 mm (22.8 in)	W1= 350 mm (13.8 in)		TD= 40°	
H3= 460 mm (18.1 in)	L2= 680 mm (26.8 in)	W2= 570 mm (22.4 in)			

Shipping

• **Weight :** 93 kg (204.6 lbs)

• **Volume :** .58 m³ (20.48 ft³)

PSU

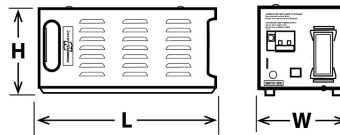

Width: W= 185 mm (7.3 in)

Height: H= 200 mm (7.9 in)

Length: L= 450 mm (17.7 in)

Weight: 24 Kg (52.8 lbs)

Installation

• **Minimum distance to illuminated surface:** 2.8 m (9.2 ft)

• **Operating position:**

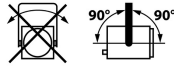

Warranty

• **Period: 2 years**

See General Sales Condition on website

Approvals



Construction

- **Housing:** Steel sheet - Aluminium
- **Colour:** Black
- **Cooling:** Low noise fan
- **Maximum ambient temperature (Ta):** 40°C (104°F)
- **Maximum case temperature (Tc):** 230°C (446°F)
- **Total heat dissipation:** 5 290 BTU/h
- **Protection rating:** 20

- **PSU housing:** Steel sheet - Aluminium
- **PSU colour:** Black
- **PSU cooling:** Convection cooling
- **PSU maximum ambient temperature (Ta):** 40°C (104°F)
- **PSU maximum case temperature (Tc):** 60°C (140°F)

Electrical compatibility

- 220/230 V - 50 Hz
- 245 V - 50 Hz
- ~~110/120 V - 60 Hz~~
- 208 V - 60 Hz
- ~~220 V - 60 Hz~~
- ~~100 V - 50 Hz~~
- ~~100 V - 60 Hz~~
- Selector: intenal

Power input



- **Type:** attached power cord
- **Cable:** H07RNF 3G1.5
- **Length:** 3 m (9,8 ft)
- **Power connector:** CEE 7/7 (2P+E NF/Schuko)

Power consumption

Voltage	Frequency	Current	Power	Power factor
230 V	50 Hz		1550 W	TBD
120 V	60 Hz			TBD
245 V	50 Hz			TBD

Power Supply Unit

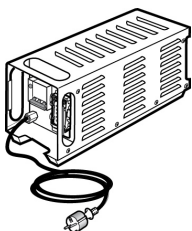





- **PSU:** Separate - Magnetic PSU
- **Lighting unit / PSU cable:** Cable attached to unit - length: 3 m (9,8 ft)
Type: 18G1,5 JZ 602-RC (CE-UL/CSA) with 16x16A+E Harting Han® connector
- **Maximum distance between lighting unit and PSU:** 25 m (82 ft)
- **Control:** Local
- **Protection:** Mains: 16A 2P2D - C curve breaker / Electronic: 6A 2P2D - C curve breaker









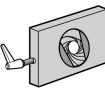

Model





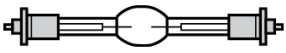





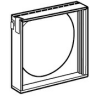

1149	1200 W HMI Followspot - 1149 Super Korrigan - 7/14,5° - Magnetic PSU
-------------	----------------------------------------------------------------------

Options

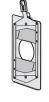
PCP1716A	16A blue 2P+E 6h IEC60309 power connector	
FRO/1117PV	Heavy duty adjustable yoke	
PG80	Ø80mm chopper kit (G80+ GR120+ adaptation kit)	
M210TM	6 ways "push/pull" colour changer	
CAG/C	Left side controls (Iris/Dimmer/Frost/Colour changer)	
FC1459	Flight-case for Compact range / GT stand / P.S.U. / accessories - Dim: 1340x710x700mm - Poids: 55 Kg	

Accessories

CCU1	Full closing iris cassette - Weight: 1,33 Kg 1 included	
PF1011	Ø210 mm metal filter holder 6 included	
SGUP	Universal "A" size gobo-holder (metal, glass, frosted glass) 1 included	
VDM100	Ø97mm frosted glass with holder 1 included	
M210B	6 ways "boomerang" colour changer - Weight: 3,36 Kg 1 included	
TC1149	Tool case with spare parts - Weight: 1,65 Kg 1 included	
HMI 1200W/DXS	HMI 1200W/DXS - Osram SFc 15.5-6 1200W 1000h 6000K lamp	
GT1000	Tripod stand - SWL: 40 Kg - max. height: 1550 mm - Weight: 9,27 Kg	
GT4000	Tripod stand with safety chain - SWL: 130 Kg - max. height: 1030 mm - Weight: 7,91 Kg	
GT4000S	Tripod stand without safety chain - SWL: 130 Kg - max. height: 1030 mm - Weight: 8,65 Kg	

JPP	Monopod stand for overhead followspot - Weight: 3,6 Kg	
T1000	TV spigot with followspots swivel head - Weight: 1,82 Kg	
T4000	Followspot mount for Ø50mm pipe (suspension or overhead) - SWL= 100 Kg - Weight: 4,88 Kg	
CAV700A	Double slot front cassette for 215x215mm accessories - Weight: ,52 Kg	
FCM100	Ø97mm CTO correction filter (5500K → 3400K) with holder	
VD120	120x120mm frosted glass	
FRO/1017PD	Heavy duty adjustable yoke - Weight: 4,33 Kg	
Kit G80	Ø80mm chopper kit (G80+ GR120+ adaptation kit) - Weight: ,69 Kg	
M210T	6 ways "push/pull" colour changer - Weight: 3,67 Kg	
M210TVCL	Light shield for M210T push/pull colour changer - Weight: 1,98 Kg	
Kit TELRAD	Telrad followspot sight with raiser and universal mounting kit - Weight: 1,23 Kg	
SDUP	Followspot cue sheet holder with universal mounting kit	
FC1459/S	Flight-case for Compact range / GT stand / P.S.U. / accessories - Weight: 55 Kg	
W/GT800	Set of 3 wheels for GT800/1000 stand - Weight: 2,33 Kg	