

# BUXIE - 1124D

ULTRA COMPACT - 575 W MSD



- **Type:** Followspot
- **Source:** 575 W MSD
- **PSU:** Electronic - hot restrike
- **Optics:** 10,5° to 22,5° zoom

Followspot

## The little spot with the powerful punch

Buxie's 2,000-hour, 575 W MSD HR lamp, gives the security of hot restrike whilst its quiet electronic PSU is fixed to the yoke for space saving. Buxie's compact dimensions make it perfect for use as a truss spot or when space is at a premium.

### Features

- **Fully closing iris:** removable for fast, easy replacement
- **Universal gobo holder:** a-size glass and metal gobo
- **Smooth dimmer shutter:** retains flat beam and colour temperature when dimming
- **Internal glass filter holder:** long term use of durable coloured, dichroic or textured glass
- **Colour changer:** 6-way, 'push/pull' colour changer system for simultaneous use of multiple filters
- **Easy focus reference:** graduated scale on side of lantern; fast and easy refocusing

### Optical

- **Variable zoom optics:** sharp focus at every beam angle

### Construction

- **Made in France :** fully manufactured in Robert Juliat premises retaining complete control over all aspects of quality
- **Bodywork:** strong sheet metal construction for durability
- **Moving parts:** smooth at all times, even when hot
- **Captive knobs and handles:** additional security when working at height or in transit
- **Easy access to all parts:** easy cleaning, re-lamping and maintenance
- **Removable assemblies:** fast-plug cable connectors and complete component assemblies (mirror, condenser set and lamp house assembly) save maintenance and cleaning time

Picture:1124D

DSEN097\_1124D - 18/05/2017

Robert Juliat reserves the right to change or alter any of the items detailed on this page, to increase or improve manufacturing techniques without prior notice.

Robert Juliat S.A.S., 32 rue de Beaumont, 60530 Fresnoy-en-Thelle - France  
Telephone : +33 (0)3 44 26 51 89 - fax : +33 (0)3 44 26 90 79 - info@robertjuliat.fr  
www.robertjuliat.com



ROBERT JULIAT

## Source



- **Lamp type:** Discharge
- **Power:** 575 W
- **Socket:** G22
- **Hot re-strike:** yes

Admissible lamps	Power *	Lumen output*	Colour temperature*	Life*	CRI* (min)
MSD 575W HR (Philips )	575 W	46 000 lm	6000K	2 000 h	75

(\*) manufacturer's data

## Optics

### Characteristics

- **Type:** Zoom
- **Beam range:** 10,5° to 22,5°
- **Focal length:** 189 - 408 mm

### Gel filter

- **Shape:** Circle
- **Standard size:** 165 mm (6.5 in)

### Gobo

- **Size:** A
- **Material:** Metal  
Glass



## Photometrics

with MSD 575W HR (Philips ) source

### • Optics @ 10.5°

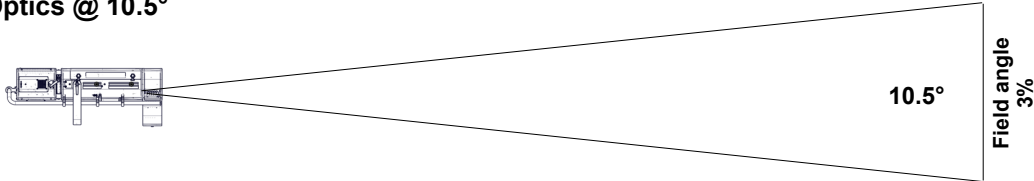

**Beam intensity**  
338 000 cd

<b>Distance</b>	10 m	15 m	20 m	25 m	30 m	35 m
<b>Diameter</b>	1.8 m	2.8 m	3.7 m	4.6 m	5.5 m	6.4 m
<b>Illumination</b>	3 400 lux	1 550 lux	850 lux	550 lux	380 lux	280 lux
<b>Distance</b>	35 ft	50 ft	65 ft	80 ft	100 ft	115 ft
<b>Diameter</b>	6.4 ft	9.2 ft	11.9 ft	14.7 ft	18.4 ft	21.1 ft
<b>Illumination</b>	280 fc	140 fc	85 fc	55 fc	34 fc	26 fc

### • Optics @ 22.5°

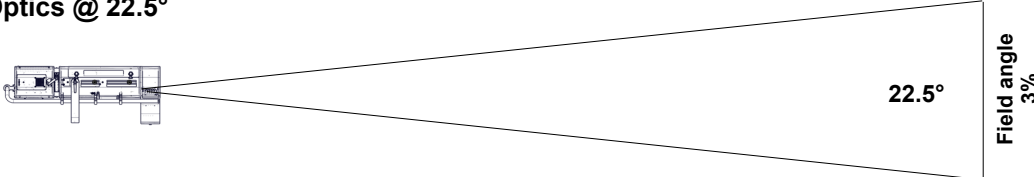

**Beam intensity**  
113 000 cd

<b>Distance</b>	10 m	15 m	20 m	25 m	30 m	35 m
<b>Diameter</b>	4 m	6 m	8 m	9.9 m	11.9 m	13.9 m
<b>Illumination</b>	1 150 lux	510 lux	290 lux	190 lux	130 lux	95 lux
<b>Distance</b>	35 ft	50 ft	65 ft	80 ft	100 ft	115 ft
<b>Diameter</b>	13.9 ft	19.9 ft	25.9 ft	31.8 ft	39.8 ft	45.7 ft
<b>Illumination</b>	95 fc	46 fc	27 fc	18 fc	12 fc	9 fc

## Dimensions and weight

### Unit

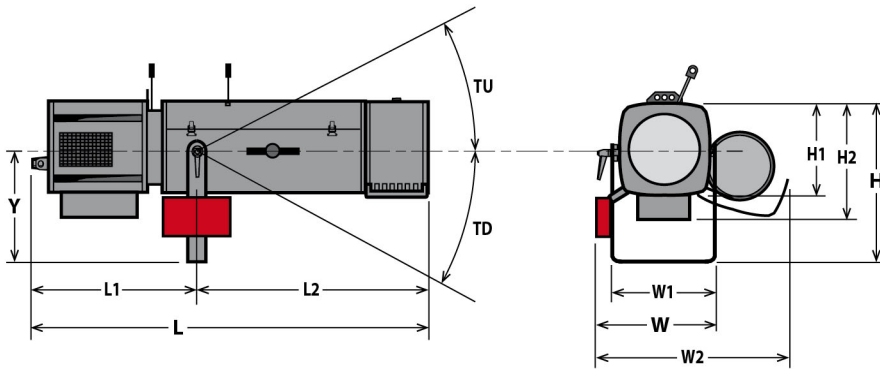

**Weight:** 16 kg (35.2 lbs)  
with PSU

Height	Length	Width	Yoke	Tilt
H= 390 mm (15.4 in)	L= 920 mm (36.2 in)	W= 330 mm (13 in)	Y= 283 mm (11.1 in)	TU= 45°
H1= 208 mm (8.2 in)	L1= 350 mm (13.8 in)	W1= 208 mm (8.2 in)		TD= 45°
H2= 265 mm (10.4 in)	L2= 570 mm (22.4 in)	W2= 490 mm (19.3 in)		

### Shipping

### PSU

• **Weight :** 22 kg (48.4 lbs)

**Width:** W= 71 mm (2.8 in)

• **Volume :** .16 m<sup>3</sup> (5.65 ft<sup>3</sup>)

**Height:** H= 162 mm (6.4 in)

**Length:** L= 245 mm (9.6 in)

**Weight:** 2.8 Kg (6.2 lbs)

### Installation

• **Minimum distance to illuminated surface:** 2.5 m ( 8.2 ft )

• **Operating position:**

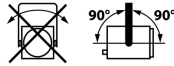

### Warranty

• **Period: 2 years**

See General Sales Condition on website

### Approvals



### Construction

- **Housing:** Steel sheet - Aluminium
- **Colour:** Black
- **Cooling:** Low noise fan
- **Maximum ambient temperature (Ta):** 40°C (104°F)
- **Maximum case temperature (Tc):** 260°C (500°F)
- **Total heat dissipation:** 2 458 BTU/h
- **Protection rating:** 20

- **PSU housing:** Steel sheet - Aluminium
- **PSU colour:** Black
- **PSU cooling:** Fan
- **PSU maximum ambient temperature (Ta):** 40°C (104°F)
- **PSU maximum case temperature (Tc):** 65°C (149°F)

### Electrical compatibility

- 220/230 V - 50 Hz
- 245 V - 50 Hz
- 110/120 V - 60 Hz
- 208 V - 60 Hz
- 220 V - 60 Hz
- 100 V - 50 Hz
- 100 V - 60 Hz
- Selector: automatic detection

### Power input



- **Type:** attached power cord
- **Cable:** H07RNF 3G1.5
- **Length:** 3 m (9,8 ft)
- **Power connector:** CEE 7/7 (2P+E NF/Schuko)

### Power consumption

Voltage	Frequency	Current	Power	Power factor
230 V	50 Hz		720 W	TBD
120 V	60 Hz		720 W	TBD
90 V	50 Hz		720 W	TBD

### Power Supply Unit

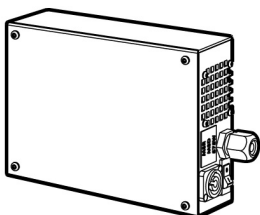



- **PSU:** On yoke - Electronic PSU - Flicker free with PFC
- **Lighting unit / PSU cable:** Cable attached to unit - length: 1,5 m (4,9 ft)  
Type: 3G1,5 H07RNF with Neutrik PowerCon® (ref. NAC3FCB) connector
- **Maximum distance between lighting unit and PSU:** 25 m (82 ft)
- **Control:** Local
- **Protection:** Mains: 10A 5x20 time-delay fuse /















## Model

<b>1124D</b>	575 W MSD Followspot - 1124D Buxie - 10,5/22,5° - Electronic PSU
--------------	--

## Options

<b>PCP1716A</b>	16A blue 2P+E 6h IEC60309 power connector	
<b>FC1124</b>	Flight-case for Ultra Compact range / GT stand - Dim: 1210x600x560mm - Poids: 35 Kg	

## Accessories

<b>IS750</b>	Full closing iris with holder - Weight: ,35 Kg <b>2 included</b>	
<b>PF1114</b>	Ø165 mm metal filter holder <b>6 included</b>	
<b>SGUX</b>	Universal "A" size gobo-holder (metal, glass, frosted glass) <b>1 included</b>	
<b>M165TP</b>	6 ways "push/pull" colour changer - Weight: 2,09 Kg <b>1 included</b>	
<b>MSD 575W HR</b>	MSD 575W HR - Philips G22 575W 2000h 6000K lamp	
<b>GT1000</b>	Tripod stand - SWL: 40 Kg - max. height: 1550 mm - Weight: 9,27 Kg	
<b>GT800</b>	Tripod stand - SWL: 40 Kg - max. height: 1550 mm - Weight: 7,98 Kg	
<b>T4000</b>	Followspot mount for Ø50mm pipe (suspension or overhead) - SWL= 100 Kg - Weight: 4,88 Kg	
<b>T/600SX</b>	Lamp compartment for 1000/1200W tungsten GX9,5 lamps - 3 meter power cable with CEE 7/7 (2P+T NF/SCHUKO) connector - Weight: 1,36 Kg	
<b>T/600VSX</b>	Lamp compartment for 1000/1200W tungsten G22 lamps with fan - 3 meter power cable with CEE 7/7 (2P+T NF/SCHUKO) connector - Weight: 2,03 Kg	
<b>VD120</b>	120x120mm frosted glass	
<b>Kit TELRAD</b>	Telrad followspot sight with raiser and universal mounting kit - Weight: 1,23 Kg	
<b>SDUP</b>	Followspot cue sheet holder with universal mounting kit	
<b>FC1124/S</b>	Flight-case for Ultra Compact range / GT stand - Weight: 35 Kg	

**W/GT800**

Set of 3 wheels for GT800/1000 stand - Weight: 2,33 Kg

