

ARAMIS - 1013+M

GRAND - 2500 W HMI



- **Type:** Followspot
- **Source:** 2500 W HMI
- **PSU:** Electronic - hot restrike
- **Optics:** 4,5° to 8° zoom

Followspot

Made for touring

Suited to the long throws of large venues, Aramis is the favoured followspot for opera houses, musicals, concerts indoors and out. Constructed to withstand the rigours of touring, its colour changer options mean it can be tailored to suit available space.

Features

- **Fully closing iris cassette:** removable for fast, easy replacement; protective backplate for extended lifespan
- **Gobo holder:** glass and metal gobos
- **Smooth dimmer shutter:** retains flat beam and colour temperature when dimming
- **Frost filter:** on flip lever for quick soft-edge beam effect
- **Horizontal chopper (optional):** for masking control in TV studios and wide stages
- **Individually removable colour frame:** gels replaced easily while colour cassette remains in place
- **Colour changer:** 6-way, self-cancelling boomerang colour-changer
- **Fast-locking focus handle:** for quick and easy change of beam size
- **Easy focus reference:** graduated scale on side of lantern; fast and easy refocusing
- **Adjustable yoke:** for optimum overhead positioning
- **Easy-to-balance counterweight:** steady movement, even at long distances
- **Stand:** perfectly weighted for maximum stability with smooth rotation for optimum performance. Easy set up; triple safety system for extra security

Optical

- **Safe lamp:** no risk of explosion and no protective clothing necessary
- **Factory set optical train:** travels safely within followspot and requires no time-consuming realignment on arrival. Uniform beam on all followspots of same type
- **Quartz condenser lens:** for dazzling light output and perfectly even beam
- **Gobo :** long distance gobo projection
- **Variable zoom optics:** sharp focus at every beam angle. Independent control of image size and focus.

Construction

- **Made in France :** fully manufactured in Robert Juliat premises retaining complete control over all aspects of quality
- **Separate PSU:** compact for easy handling and rapid maintenance
- **Cooling:** highly efficient multi-zone cooling of lamp house and oversized lamp holder heat-sinks for maximum reliability and durability
- **Bodywork:** strong sheet metal construction for durability
- **Ergonomic wrap-around handle:** comfort, safety and practicality from all operating positions
- **Moving parts:** smooth at all times, even when hot
- **Captive knobs and handles:** additional security when working at height or in transit
- **Easy access to all parts:** easy cleaning, re-lamping and maintenance
- **Removable assemblies:** fast-plug cable connectors and complete component assemblies (mirror, condenser set and lamp house assembly) save maintenance and cleaning time
- **Safety:** safety switch for secure access to the lamp

Picture:1013+

DSEN128_1013+M - 16/06/2017

Robert Juliat reserves the right to change or alter any of the items detailed on this page, to increase or improve manufacturing techniques without prior notice.

Robert Juliat S.A.S., 32 rue de Beaumont, 60530 Fresnoy-en-Thelle - France
Telephone : +33 (0)3 44 26 51 89 - fax : +33 (0)3 44 26 90 79 - info@robertjuliat.fr
www.robertjuliat.com



ROBERT JULIAT

Source



- **Lamp type:** Discharge
- **Power:** 2500 W
- **Socket:** SFa 21
- **Hot re-strike:** yes

Admissible lamps	Power *	Lumen output*	Colour temperature*	Life*	CRI* (min)
HMI 2500W/S XS (Osram)	2 500 W	240 000 lm	6000K	500 h	>90

(*) manufacturer's data

Optics

Characteristics

- **Type:** Zoom
- **Beam range:** 4,5° to 8°
- **Focal length:** 393 - 700 mm

Gel filter

- **Shape:** Circle
- **Standard size:** 270 mm (10.6 in)

Gobo

- **Size:** B
- **Material:** Metal
Glass



Photometrics

with HMI 2500W/S XS (Osram) source

• Optics @ 4.5°

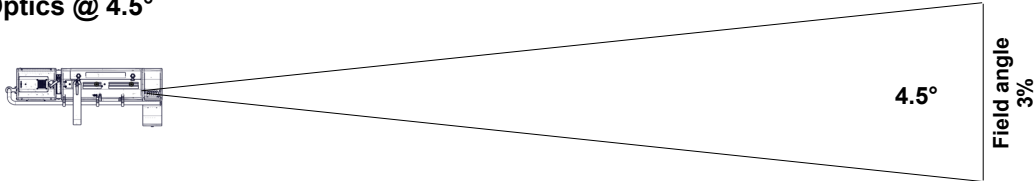

Beam intensity
6 030 000 cd

Distance	30 m	40 m	50 m	60 m	70 m	80 m
Diameter	2.4 m	3.1 m	3.9 m	4.7 m	5.5 m	6.3 m
Illumination	6 800 lux	3 800 lux	2 450 lux	1 700 lux	1 250 lux	950 lux
Distance	100 ft	130 ft	165 ft	195 ft	230 ft	260 ft
Diameter	7.9 ft	10.2 ft	13 ft	15.3 ft	18.1 ft	20.4 ft
Illumination	610 fc	360 fc	230 fc	160 fc	120 fc	90 fc

• Optics @ 8°

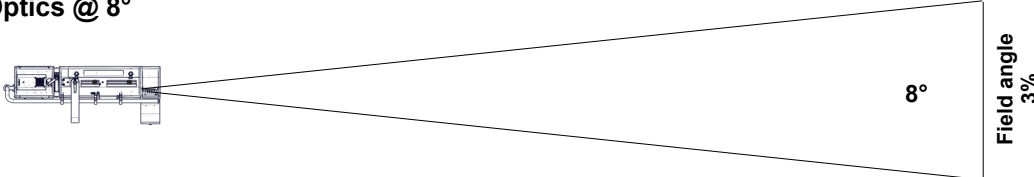

Beam intensity
1 900 000 cd

Distance	30 m	40 m	50 m	60 m	70 m	80 m
Diameter	4.2 m	5.6 m	7 m	8.4 m	9.8 m	11.2 m
Illumination	2 150 lux	1 200 lux	770 lux	530 lux	390 lux	300 lux
Distance	100 ft	130 ft	165 ft	195 ft	230 ft	260 ft
Diameter	14 ft	18.2 ft	23.1 ft	27.3 ft	32.2 ft	36.4 ft
Illumination	200 fc	120 fc	70 fc	50 fc	36 fc	29 fc

Dimensions and weight

Unit

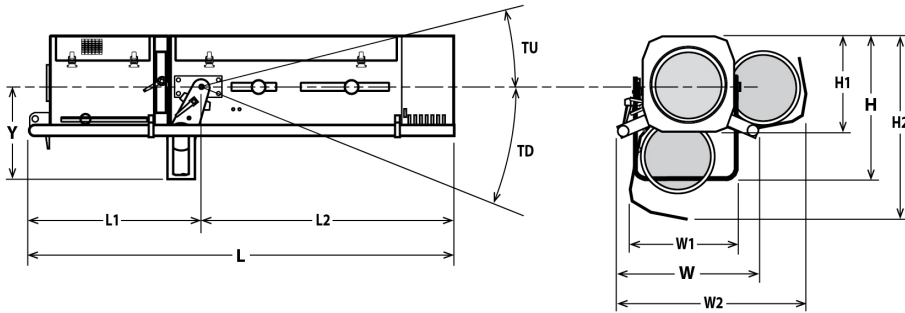

Weight: 59 kg (129.8 lbs)

Height	Length	Width	Yoke	Tilt
H= 505 mm (19.9 in)	L= 1490 mm (58.7 in)	W= 550 mm (21.7 in)	Y= 350 mm (13.8 in)	TU= 35°
H1= 320 mm (12.6 in)	L1= 640 mm (25.2 in)	W1= 300 mm (11.8 in)		TD= 42°
H3= TBD mm (0 in)	L2= 850 mm (33.5 in)	W2= 700 mm (27.6 in)		

Shipping

• **Weight :** 129 kg (283.8 lbs)

• **Volume :** 1.11 m³ (39.02 ft³)

PSU

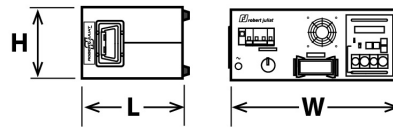

Width: W= 452 mm (17.8 in)

Height: H= 194 mm (7.6 in)

Length: L= 354 mm (13.9 in)

Weight: 14.5 Kg (31.9 lbs)

Installation

• **Minimum distance to illuminated surface:** 4.0 m (13.1 ft)

• **Operating position:**

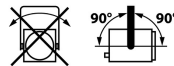

Warranty

• **Period: 2 years**

See General Sales Condition on website

Approvals



Construction

- **Housing:** Steel sheet - Aluminium
- **Colour:** Black
- **Cooling:** Low noise fan
- **Maximum ambient temperature (Ta):** 40°C (104°F)
- **Maximum case temperature (Tc):** 130°C (266°F)
- **Total heat dissipation:** 9 216 BTU/h
- **Protection rating:** 20

- **PSU housing:** Steel sheet - Aluminium
- **PSU colour:** Black
- **PSU cooling:** Fan
- **PSU maximum ambient temperature (Ta):** 40°C (104°F)
- **PSU maximum case temperature (Tc):** 55°C (131°F)

Electrical compatibility

- 220/230 V - 50 Hz
- 245 V - 50 Hz
- ~~110/120 V - 60 Hz~~
- 208 V - 60 Hz
- 220 V - 60 Hz
- ~~100 V - 50 Hz~~
- ~~100 V - 60 Hz~~
- Selector: automatic detection

Power input



- **Type:** removeable power cord with Neutrik PowerCon® (ref. NAC3FCA) connector (included)
- **Cable:** H07RNF 3G1.5
- **Length:** 3 m (9,8 ft)
- **Power connector:** CEE 7/7 (2P+E NF/Schuko)

Power consumption

Voltage	Frequency	Current	Power	Power factor
230 V	50 Hz		2700 W	TBD
208 V	60 Hz		2700 W	TBD
245 V	50 Hz		2700 W	TBD

Power Supply Unit

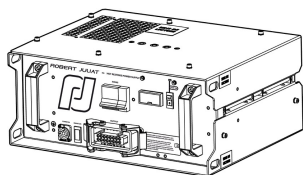



- **PSU:** Separate - Electronic PSU - Flicker free with PFC
- **Lighting unit / PSU cable:** Removable cable - length: 3 m (9,8 ft)
Type: 18G1,5 H07RNF with 16x16A+E Harting Han® connectors
- **Maximum distance between lighting unit and PSU:** 25 m (82 ft)
- **Control:** Local
- **Protection:** Mains: 15A 2P2D - C curve breaker - UL / Electronic: 2A 1P1D - C curve breaker - UL









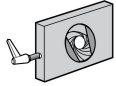

Model

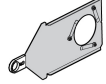



1013+M	2500 W HMI Followspot - 1013+M Aramis - 4,5/8° - Electronic PSU
---------------	---

Options

PCP1716A	16A blue 2P+E 6h IEC60309 power connector	
M270TM	6 ways "push/pull" colour changer	
FC1015	Flight-case for 2.5K Grand range / GT4000 stand / P.S.U. / accessories - Dim: 2010x600x810mm - Poids: 78 Kg	

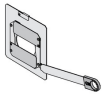
Accessories

CCU2	Full closing iris cassette - Weight: 1,35 Kg 1 included	
PF1013	Ø270 mm metal filter holder 6 included	
SGS	Universal "B" size gobo-holder (metal, glass, frosted glass) - Weight: ,22 Kg 1 included	
FCM85	Ø85mm CTO correction filter (5500K → 3400K) with holder 1 included	
VDM85	Ø85mm frosted glass with holder 1 included	
M270B	6 ways "boomerang" colour changer - Weight: 4,61 Kg 1 included	
TC1013	Tool case with spare parts - Weight: 2,59 Kg 1 included	
HMI 2500W/S XS	HMI 2500W/S XS - Osram SFa 21 2500W 500h 6000K lamp	
GT4000	Tripod stand with safety chain - SWL: 130 Kg - max. height: 1030 mm - Weight: 7,91 Kg	
GT4000S	Tripod stand without safety chain - SWL: 130 Kg - max. height: 1030 mm - Weight: 8,65 Kg	
JPP	Monopod stand for overhead followspot - Weight: 3,6 Kg	
T4000	Followspot mount for Ø50mm pipe (suspension or overhead) - SWL= 100 Kg - Weight: 4,88 Kg	
TMG1	Tournesol - "B" size motorised gobo rotator (with TSG1 gobo holder) - Weight: 2,73 Kg	

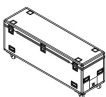
TSG1	"B" size gobo-holder for Tournesol TMG1 - Weight: ,27 Kg	
G56H	Ø56mm horizontal chopper - Weight: ,2 Kg	
M270T	6 ways "push/pull" colour changer - Weight: 5,29 Kg	
Kit TELRAD	Telrad followspot sight with raiser and universal mounting kit - Weight: 1,23 Kg	
SDUP	Followspot cue sheet holder with universal mounting kit	
FC1015/S	Flight-case for 2.5K Grand range / GT4000 stand / P.S.U. / accessories - Weight: 78 Kg	
MLA	Mini yoke (with screws) - Weight: ,9 Kg	