

# CIN'K - 350LFV

CIN'K - 5000 W TUNGSTEN

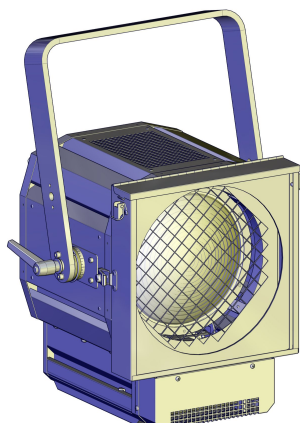

- **Type:** Single lens luminaire
- **Source:** 5000 W Tungsten
- **Optics:** 250 mm Fresnel lens
- **Silent cooling fan for colour cassette**

Single lens

## 5K Fresnel designed specifically for theatres

Cin'k's 250 mm lens gives an output which exceeds that of comparable 300 mm fixtures, and its theatre-inspired front cassette has no distracting light spill. An ideal tungsten source for theatres and opera houses, large venues and rental houses.

### Features

- **Silent cooling fan for colour cassette:** to extend the life of dark colour gels
- **Theatre front cassette:** no light spill to distract audiences or performers
- **Colour runners:** double runners to hold accessories and colour filters
- **Focus reference:** index for easy focus reference
- **Tilt reference on hanging yoke:** index for rapid re-positioning

### Optical

- **250 mm lens:** light output equivalent to 'studio' 300 mm fixtures

### Construction

- **Made in France :** fully manufactured in Robert Juliat premises retaining complete control over all aspects of quality
- **Bodywork:** strong sheet metal construction for durability
- **Moving parts:** smooth at all times, even when hot
- **Captive knobs and handles:** additional security when working at height or in transit
- **Access:** easy access to lamp house and lenses through front opening for fast and efficient maintenance
- **Easy access to all parts:** easy cleaning, re-lamping and maintenance
- **Removable assemblies:** fast-plug cable connectors and complete component assemblies (mirror, condenser set and lamp house assembly) save maintenance and cleaning time
- **Specially designed handle:** for fast cable changing without having to go inside the unit
- **Safety grid:** earthed safety grid fitted as standard
- **Safety first:** front accessories safety cable attachment point

Picture:350LFV

DSEN032\_350LFV - 16/06/2017

Robert Juliat reserves the right to change or alter any of the items detailed on this page, to increase or improve manufacturing techniques without prior notice.

Robert Juliat S.A.S., 32 rue de Beaumont, 60530 Fresnoy-en-Thelle - France  
Telephone : +33 (0)3 44 26 51 89 - fax : +33 (0)3 44 26 90 79 - info@robertjuliat.fr  
www.robertjuliat.com



ROBERT JULIAT

## Source



- **Lamp type:** Tungsten
- **Socket:** G38

Admissible lamps	Power *	Lumen output*	Colour temperature*	Life*
LIF: CP85 (CP29)	5 000 W	135 000 lm	3200K	400 h

(\*) *manufacturer's data*

## Optics

### Characteristics

- **Type:** Single lens
- **Beam range:** 10° to 54°
- **Lens:** 250 mm Fresnel lens

### Gel filter

- **Shape:** Square
- **Standard size:** 333x333 mm (13.1x13.1 in)

## Photometrics

with LIF: CP85 (CP29) source

### • Optics @ 17°

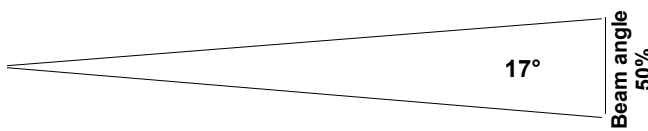
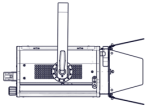

**Beam intensity**  
400 000 cd

<b>Distance</b>	5 m	10 m	15 m	20 m	25 m	30 m
<b>Diameter</b>	1.5 m	3 m	4.5 m	6 m	7.5 m	9 m
<b>Illumination</b>	16 500 lux	4 050 lux	1 800 lux	1 010 lux	650 lux	450 lux
<b>Distance</b>	15 ft	35 ft	50 ft	65 ft	80 ft	100 ft
<b>Diameter</b>	4.5 ft	10.5 ft	14.9 ft	19.4 ft	23.9 ft	29.9 ft
<b>Illumination</b>	1 800 fc	330 fc	170 fc	95 fc	65 fc	41 fc

## Dimensions and weight

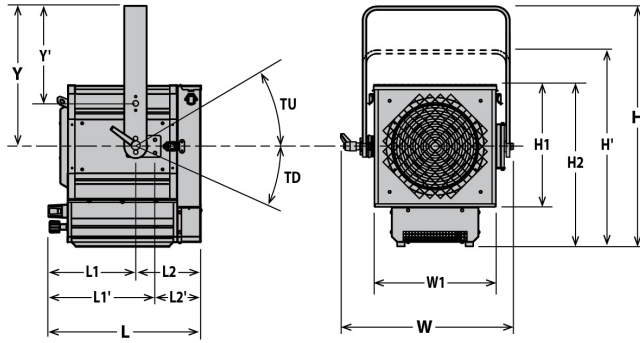

**Weight:** 18 kg (39.6 lbs)

Height	Length	Width	Yoke	Tilt
H= 560 mm (22 in)	L= 425 mm (16.7 in)	W= 465 mm (18.3 in)	Y= 270 mm (10.6 in)	TU= TBD°
H'= 670 mm (26.4 in)	L1= 250 mm (9.8 in)	W1= TBD mm (0 in)	Y'= 390 mm (15.4 in)	TD= TBD°
H1= TBD mm (0 in)	L1'= 290 mm (11.4 in)			
H2= 450 mm (17.7 in)	L2= TBD mm (0 in)			

## Shipping

- **Weight :** 22.5 kg (49.5 lbs)
- **Volume :** .14 m<sup>3</sup> (4.94 ft<sup>3</sup>)

## Installation

- **Minimum distance to illuminated surface:** 4.5 m (14.8 ft)
- **Operating position:**

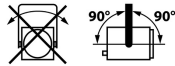

## Warranty

- **Period: 2 years**  
See General Sales Condition on website

## Approvals



## Construction

- **Housing:** Steel sheet - Aluminium
- **Colour:** Black
- **Cooling:** Low noise fan
- **Maximum ambient temperature (Ta):** 40°C (104°F)
- **Maximum case temperature (Tc):** 350°C (662°F)
- **Total heat dissipation:** 17 066 BTU/h
- **Protection rating:** 20

## Electrical compatibility

- 230/240 V - 50 Hz
- 115/120 V - 60 Hz

## Power input



- **Type:** attached power cord
- **Cable:** EWKF 3G4
- **Length:** 3 m (9,8 ft)
- **Power connector:** 32A blue 2P+E 6h IEC60309 (CEE 32)

## Power consumption

Voltage	Frequency	Current	Power
230 V	50 Hz	22 A	5000 W











## Model

<b>350LFV</b>	5000 W Tungsten Single lens luminaire - G38 socket - 250mm Fresnel - 350LFV Cin'k - with fan
---------------	--

## Options

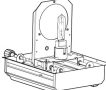
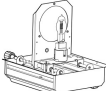
<b>LT-Fresnel</b>	Licht-Technik motorisation controlled by DMX: Pan, tilt, focus, barndoors, colour changer
-------------------	---

## Accessories

<b>PF325</b>	333x333mm metal filter holder - Weight: ,52 Kg <b>1 included</b>	
<b>G325L</b>	333x333mm safety grid - Weight: ,44 Kg <b>1 included</b>	
<b>CP85 (CP29)</b>	CP85 (CP29) - G38 5000W 230V 400h 3200K lamp	
<b>PFR325</b>	600x600 mm extended metal filter holder with 4 clips - Weight: 1,11 Kg	
<b>CF325</b>	4 rotating leaves on a rotating barndoor - 333x333mm (without safety cable) - Weight: 2,11 Kg	
<b>PFR CF325</b>	Extended filter holder and rotating barndoor set - 333x333mm	
<b>T/312LF</b>	312LF lamp compartment (P.S.U. required) - Weight: 5,28 Kg	
<b>T/325LF</b>	325LF lamp compartment - 3 meter power cable with CEE 7/7 (2P +T NF/SCHUKO) connector - Weight: 4,95 Kg	
<b>T/326LFV</b>	326LFV lamp compartment (P.S.U. required) - Weight: 10,48 Kg	
<b>T/350LF</b>	350LF lamp compartment - 3 meter power cable with CEE 7/7 (2P +T NF/SCHUKO) connector	
<b>876</b>	Hook clamp 40x10mm with 28mm M10 screw for Ø35 to 50mm pipes - SWL: 50Kg - Weight: 1,25 Kg	
<b>880</b>	Hook clamp 40x10mm with 28mm M10 screw for Ø50 to 63mm pipes - SWL: 50Kg - Weight: 1,36 Kg	
<b>CS2</b>	Safety cable Ø3 mm L= 600mm - SWL: 75 Kg	