

SILVER STAR  
PROFESSIONAL LIGHTING



SILVER STAR  
Professional Lighting

2019-2020 PRODUCTION



2019--2020 PRODUCTION A



No.18 HuaHui Road, Huashan Town, Huadu District, GuangZhou 510880 CHINA

020-86947788 020-86943773 sales@yajiang.cn www.yajiang.cn

Since 1985

# CONTENTS

## NEPTUNE

|    |                      |           |
|----|----------------------|-----------|
| 01 | NEPTUNE 1500 PROFILE | SS680SCM  |
| 03 | NEPTUNE 400 HYBRID   | SS676SCM  |
| 05 | NEPTUNE 200 BEAM     | SS673SCM  |
| 07 | NEPTUNE 400 FX WASH  | SS671XCEM |
| 09 | NEPTUNE 400 WASH     | SS672XCEM |

## PLUTO

|    |                        |            |
|----|------------------------|------------|
| 11 | PLUTO 600 PROFILE      | SS660SC    |
| 13 | PLUTO 600 SPOT         | SS661SC    |
| 15 | PLUTO 600 PROFILE WASH | SS664SC    |
| 17 | PLUTO 600 WASH         | SS663SC    |
| 18 | PLUTO 350              | SS659SC    |
| 19 | PLUTO 300              | SS657SC HD |
| 21 | PLUTO 250              | SS662SC    |
| 23 | PLUTO 200              | SS658SC    |
| 25 | PLUTO 4000XE           | SS656XCE   |
| 27 | PLUTO 2000XE           | SS646XCE   |
| 31 | PLUTO 800XE            | SS636XCE   |

## CYAN

|    |                   |          |
|----|-------------------|----------|
| 33 | CYAN 12000XCE MK4 | SS644XCE |
| 35 | CYAN 6000XCE MK4  | SS631XCE |

## STAGER

|    |                    |                    |
|----|--------------------|--------------------|
| 37 | AURORA 150 HEX     | SS820XHM           |
| 39 | AURORA 150 TW/TC   | SS820TWM/SS820TCM  |
| 41 | ECLIPSE MINI       | SS817SW/SC         |
| 43 | mobi ECLIPSE MINI  | SS818SW/SC         |
| 45 | ECLIPSE MINI HD    | SS867SW HD/SC HD   |
|    | ECLIPSE MINI HDD   | SS867SW HDD/SC HDD |
| 47 | ECLIPSE 750 HD     | SS827SW HD/SC HD   |
|    | ECLIPSE D750 HD    | SS827SW HDD/SC HDD |
| 49 | ECLIPSE 1000 RGBAL | SS847XAL           |
| 51 | ECLIPSE 750 IP     | SS857SWT/SCT       |
| 53 | ECLIPSE COLOR IP   | SS857XCET/XALT     |
| 55 | FREZNO MINI        | SS868SW/SC         |
|    | FREZNO MINI D      | SS868SWD/SCD       |
| 57 | mobi FREZNO MINI   | SS869SW/SC         |

## STAGER

|    |                    |                    |
|----|--------------------|--------------------|
| 59 | FREZNO zm-1 HD     | SS810SW HD/SC HD   |
|    | FREZNO zm-1 HDD    | SS810SW HDD/SC HDD |
| 61 | FREZNO Ze-2 HD     | SS808SW HD/SC HD   |
|    | HDDFREZNO ze-D2 HD | SS808SW HDD/SC HDD |
| 63 | FREZNO ze-3 HD     | SS811SW HD/SC HD   |
| 65 | FREZNO ze-2 RGBAL  | SS815XAL           |
| 67 | MYCYC2             | SS822XAL           |
| 69 | MAXCYC             | SS809XCA           |
| 71 | ULTIcyc            | SS819XS            |
| 73 | TRACER             | SS824SC            |

## TOURZ

|     |                        |               |
|-----|------------------------|---------------|
| 75  | Neo CYC IP             | SS361XALM     |
| 77  | MINI CYC IP            | SS364XALM     |
| 79  | Neo CYC                | SS356XAL      |
| 81  | MINI CYC               | SS366XAL      |
| 83  | RAYTHEON               | SS353XCEM     |
| 85  | X3 iZOOM               | SS350XCEM     |
| 87  | PixiCYC/ETZ 12         | SS359XCET     |
| 89  | PixiCYC/EZ 12          | SS360XCE      |
| 91  | SUPERNOVA              | SS352XCEM     |
|     | SUPERNOVA/ETZ          | SS352XCET     |
| 93  | MYNOVA                 | SS354XCEM     |
| 95  | NOVA                   | SS349XCEM     |
| 97  | MININOVA               | SS355XCEM     |
| 99  | SUPER SOLAR ze/ETZ MK3 | SS342XCE/XCET |
|     | SUPER SOLAR ze/ETZ MK3 | SS342XCET     |
| 101 | SOLAR ze/ETZ MK3       | SS345XCEM     |
|     | SOLAR ze/ETZ MK3       | SS345XCE/XCET |
| 103 | BOOMER X2/TZ IP MK3    | SS332XCT      |
| 105 | BOOMER/TZ IP MK3       | SS330XCT      |
| 107 | apariSPOT X4           | SS373XCE      |
| 109 | CAM3/EMZ               | SS358XCEM     |
|     | CAM3/ETZ               | SS358XCE/XCET |
| 111 | AOX/ET MK2             | SS347XCET     |
| 113 | cubeLITE 9             | SS357XLEM     |
| 115 | cubeLITE 4             | SS367XLEM     |
| 117 | mobiLITE/ETZ           | SS337XAE      |
| 119 | miniLITE               | SS348XSE      |

## ACCESSORIES

|     |                 |     |             |
|-----|-----------------|-----|-------------|
| 121 | POWER CABLE     | 128 | CLAMP       |
| 126 | SIGNAL CABLE    | 129 | UPLOADER    |
| 127 | HANGING BRACKET | 130 | SAFETY BELT |



Neptune series represents the new era of IP LED moving heads! It presents the latest industrial sophisticated waterproof design and super-compact body, innovational and efficient optic system, stunning dynamic effects, it suits for all season and various applications! It will be new shining star rising up in the market!



Neptune series represents the new era of IP LED moving heads! It presents the latest industrial sophisticated waterproof design and super-compact body, innovational and efficient optic system, stunning dynamic effects, it suits for all season and various applications! It will be new shining star rising up in the market!



## NEPTUNE 1500 PROFILE SS680SCM

NEPTUNE 1500 PROFILE is a high power LED moving spot + profile, with the super efficient optic system, 1:7 times zoom 7-50°, the Max. output is 71000lx @ 5m; It is a kind of final version stage light, accurate and efficient motor can provide not only large pan angle and tilt angles but also with smooth and high speed. NEPTUNE 1500 PROFILE has image-cutting system can cut out any polygon, and with zoom, focus, prism, color wheel, CMY, gobo wheels, iris, frost can supply high-quality beam colors and gobos. NEPTUNE 1500 PROFILE is equipped with animation wheel which can create dynamic water and dynamic fire effect. NEPTUNE 1500 PROFILE is designed for the cultural center, function hall, banquet hall, and rental performance market.



To get more infos

### DIMENSIONS

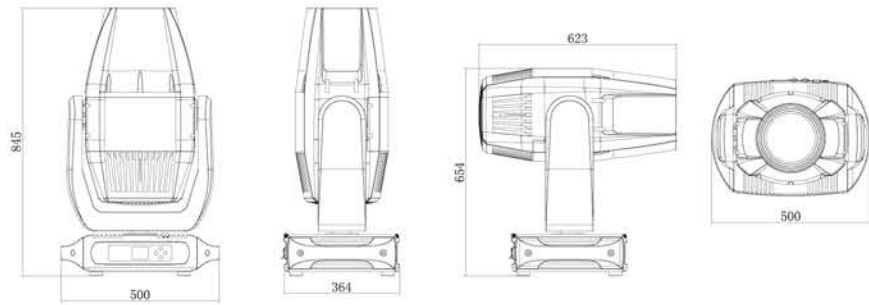

### ACCESSORIES

Accessories not included unless otherwise stated

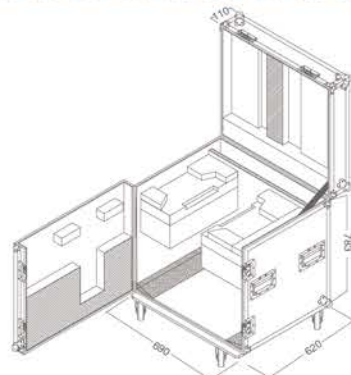

Flight Case  
( P20227 )

### Optical system

- Light source: 1000W module
- Angle: 7-50°

### Electrical Specs

- Voltage: AC100-240V, 50/60Hz
- Max. Power: 1300W
- Drive Current: 4A
- Power Connection: Anti-loose power socket in
- Signal socket: 3pin or 5pin in and out, RJ45 in and out for Art-net

### Control System

- Pan/Tilt rotation: 540°/270°(8-16bit)
- Dimmer: 0-100%16Bit
- Cooling: Natural radiation
- Control: DMX512, RDM, ARTNET, SACN, WEB server, W-DMX (optional)
- Display: On board Control, Custom Mode, 0-25Hz Strobe
- Con Personality: BASIC/29CHS, STANDARD/38CHS, Extend/43CHS
- Special: Pan/Tilt movement blackout, User-selectable pan/tilt ranges

### Work Environment

- Ambient Temp: -20°C-45°C
- IP Rated: IP65

### Fixed Gobo



### Framing System

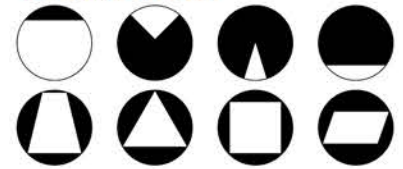

### Animation Wheel



### Effect synthetic system

- Rotating Gobo: 7 Gobos+ White, Gobo-flow effect, Gobo shake, Bi-directional rotation
- Static Gobo: 8Gobos+White, Gobo-flow effect, Gobo shake
- Colors: One color wheel(6 dichroic -filters+ White, Rainbow-flow effect)
- CMYK: CMY wheel, Linear CTO function
- Prism: One piece of 5 F prisms with bi-directional rotation, Speed adjustable One piece of linear prism with bi-directional rotation, Speed adjustable
- Framing system: 4 shutter blade; Each blade's angel and direction can be individual controlled, fully blackout; The whole Framing module is ±45°.
- Animation Wheel: Bi-directional rotation, Speed adjustable
- Iris: 5-100% linearly adjustable with macro
- Focus: Motorized linear focus
- Zoom: Motorized linear Zoom
- Frost: 1 Frost filter

### Appearance

- Size: 500x364x845mm
- Weight: 50kg
- Casing: Flame-retardant plastic (V0) Die-cast aluminum
- Color: Black

### Certification

- CE, MET

### Rotation Gobo

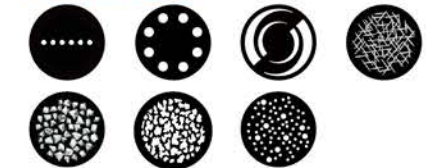

### Colors



### CMY + CTO



### ILLUMINANCE AT DISTANCE

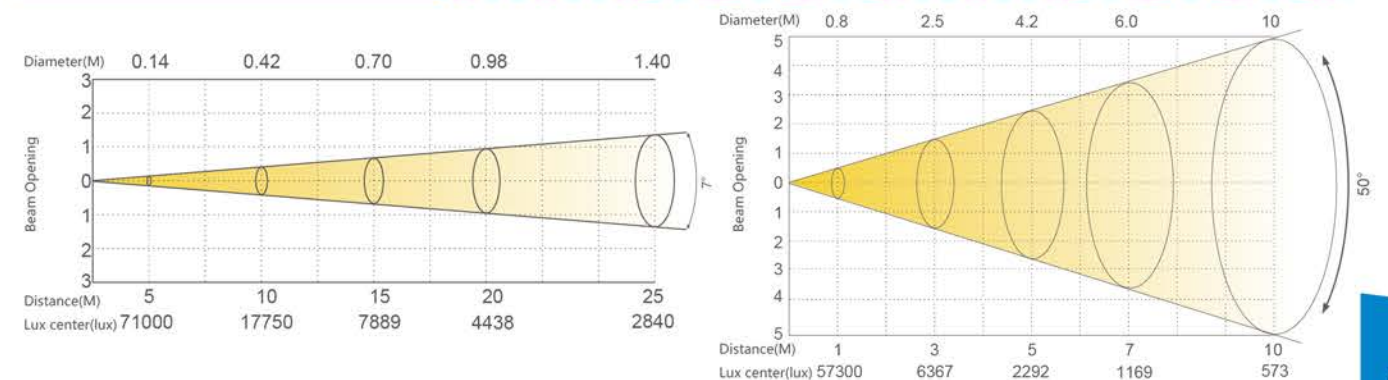



## NEPTUNE 400 HYBRID SS676SCM

NEPTUNE 400 HYBRID is a powerful IP hybrid moving head, with high-efficient optics, wide zoom angle from 3-30°, provides a strong Beam and Spot effect. It has fast and silent X/Y movement, professional high quality color wheel, extremely clean static and rotation gobo wheel projection, amazing double prism effect (8 facet and linear prism)! Perfect product for outdoor concerts/events, commercial complex, theme park, amusement park and rental touring market.



To get more infos

### DIMENSIONS

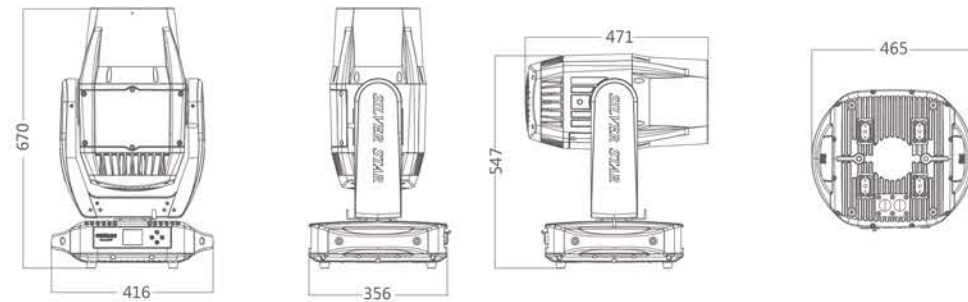

### ACCESSORIES

Accessories not included unless otherwise stated

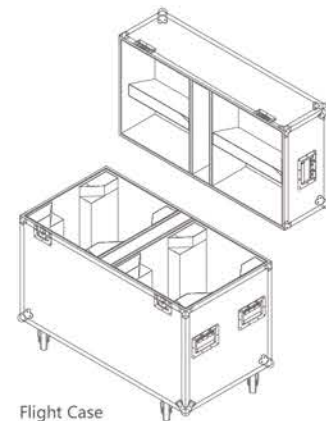

Flight Case (P20225)

### Optical system

- Light source: 300W module
- Angle: 3-30°

### Electrical Specs

- Voltage: AC100-240V,50/60Hz
- Max. Power: 400W
- Drive Current: 5A
- Power Connection: Power in
- Signal socket: 3pin or 5pin in and out, RJ45 in and out for Art-net

### Control System

- Pan/Tilt rotation: 540°/270° (8-16bit)
- Dimmer: 0-100%16Bit
- Cooling: Forced Convection
- Control: DMX512, RDM, ARTNET, SACN, W-DMX (optional)
- Display: On board Control, Custom Mode, 0-25Hz Strobe
- Con Personality: BASIC/20CHS, STANDARD/24CHS, Extend/28CHS

### Certification

- CE, MET

### Fixed Gobo



### Colors



### Effect synthetic system

- Rotating Gobo: 8 Gobos+ White, Gobo-flow effect, Gobo shake, Bi-directional rotation
- Static Gobo: 12 Gobos+ White, Gobo-flow effect, Gobo shake
- Colors: CMY, One color wheel(8dichroic-filters+White, Rainbow-flow effect)
- Prism: One piece of 5 F prism with bi-directional rotation, Speed adjustable, One piece of linear prism with bi-directional rotation,
- Speed adjustable, Can use superposition
- Focus: Motorized linear focus

### Appearance

- Size: 416x356x670mm
- Weight: 34.5kg
- Casing: Flame-retardant plastic (V0), Die-cast aluminum
- Color: Black

### Work Environment

- Ambient Temp: -20°C-45°C
- IP Rated: IP65

### Rotation Gobo



### CMY



### ILLUMINANCE AT DISTANCE

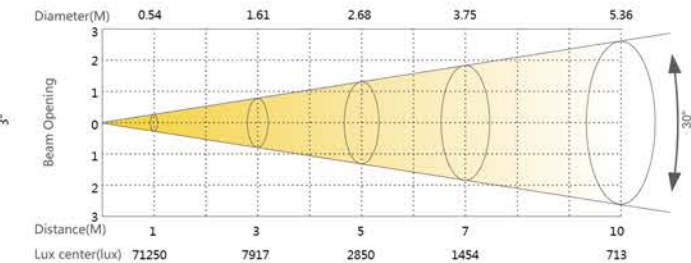
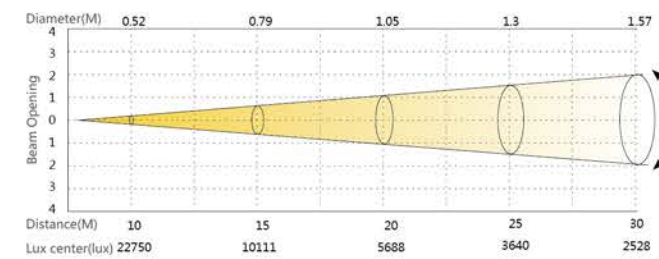



## NEPTUNE 200 BEAM SS673SCM

NEPTUNE 200 BEAM is an ultra-compact IP beam moving head, which deliver unbelievable strong and powerful output, Provide a solid fat, sharp and clean beam at 1.7°. It has a super-fast and precise X/Y movement, professional beam effect, fast multi-gobo exchanging and clean projection. It is an ideal product for outdoor concerts/events, amusement park, theme park and the rental touring market.



To get more infos

### Optical system

- Light source: 100W module
- Angle: 1.7°

### Electrical Specs

- Voltage: AC100-240V, 50/60Hz
- Max. Power: 180W
- Drive Current: 3.8A
- Power Connection: Power in/out
- Signal socket: 3pin or 5pin in and out, RJ45 in and out for Art-net

### Control System

- Pan/Tilt rotation: 540°/270°(8-16bit)
- Dimmer: 0-100%16Bit
- Cooling: Forced Convection
- Control: DMX512, RDM, ARTNET, W-DMX (optional)
- Display: On board Control, Custom Mode, 0-25Hz Strobe
- Con Personality: BASIC/12CHS, STANDARD/15CHS, Extend/18CHS
- Special: Pan/Tilt movement blackout, User-selectable pan/tilt ranges

### Certification

- CE, MET

### Effect synthetic system

- Rotating Gobo: 8 Gobos+ White, Gobo-flow effect, Gobo shake, Bi-directional rotation
- Colors: One color wheel(9 dichroic -filters+ White, Rainbow-flow effect)
- Prism: 1pcs 8+16 facet prism prisms with bi-directional rotation, Speed adjustable, One piece of linear prism with bi-directional rotation, Speed adjustable
- Focus: Motorized linear focus

### Appearance

- Size: 410x280x483mm
- Weight: 21kg
- Casing: Flame-retardant plastic (V0), Die-cast aluminum
- Color: Black

### Work Environment

- Ambient Temp: -20 C-45 C
- IP Rated: IP65

## DIMENSIONS

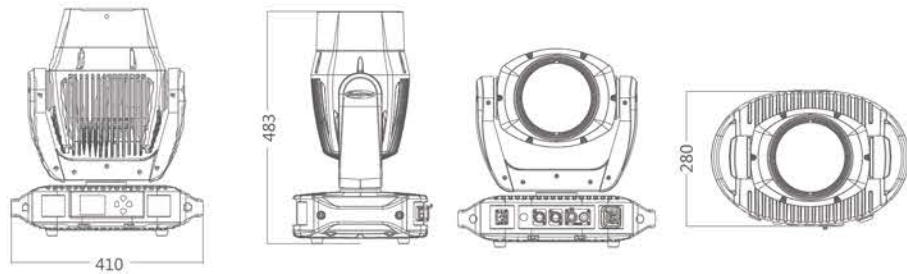

## ACCESSORIES

Accessories not included unless otherwise stated

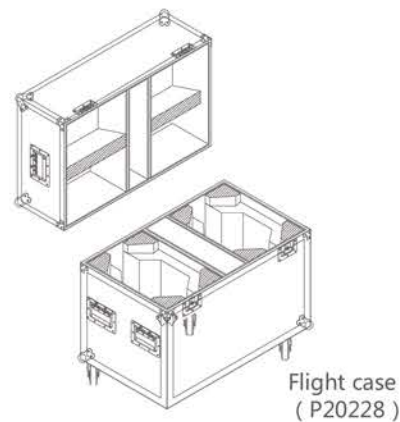

Flight case  
( P20228 )

### Rotation Gobo

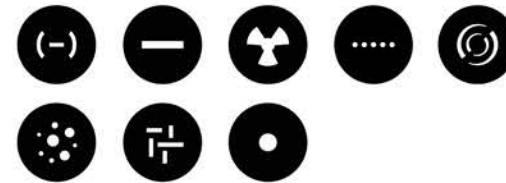

### Colors

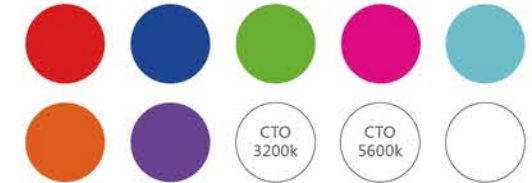

## ILLUMINANCE AT DISTANNXE

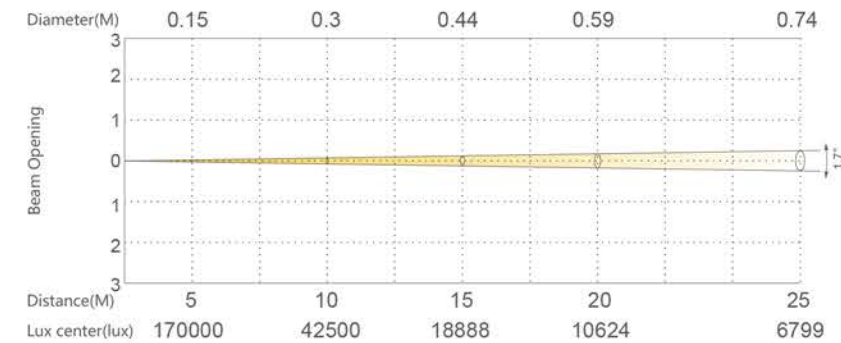



## NEPTUNE 400 FX WASH SS671XCEM

NEPTUNE 400 FX WASH is an innovative IP washing moving head, combined with 7x40W and 60W RGBW LED, one LED ring effect and great optics design. It is built in HSIC system, mixing color much easier and faster, creating a brilliant color effect. Extremely perfect dynamic effect by individual pixel control. Wide zoom range from 5-35°. Small compact with a very light weight 22KG. It is an ideal products for outdoor concerts/events, commercial complex, theme park, amusement park and rental touring market.



To get more infos

### DIMENSIONS

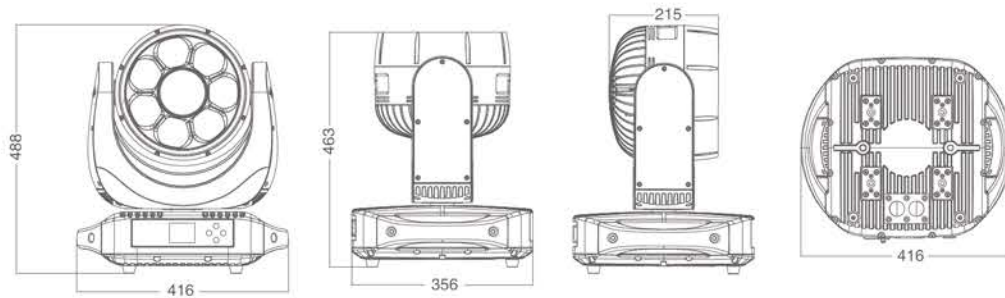

### ACCESSORIES

Accessories not included unless otherwise stated

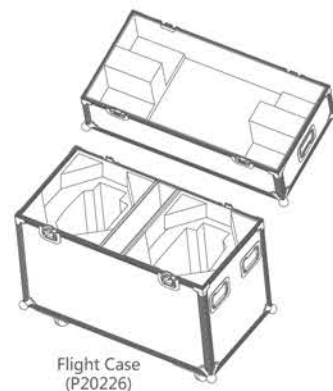

Flight Case  
(P20226)

### Optical system

- Light source: 7X40W(RGBW) + 60W(RGBW)
- Angle: 5°-35°

### Electrical Specs

- Voltage: AC100-240V,50/60Hz
- Max. Power: 350W
- Drive Current: 4A
- Power Connection: power in
- Signal socket: 3pin or 5pin in and out,RJ45 in and out for Art-net

### Control System

- Pan/Tilt rotation: 540°/270°
- Dimmer: 0-100%16Bit
- Cooling: Forced Convection
- Control: DMX512、RDM、ARTNET、SACN  
W-DMX (optional)
- Display: On board Control, Custom Mode,0-25Hz Strobe
- Con Personality: SSP/21CHS、TOUR/26CHS、TR16/33CHS、  
CMY/27CHS、HSIC/23CHS、PIXEL/48CHS
- Special: Pan/Tilt movement blackout, User-selectable pan/tilt ranges

### Effect synthetic system

- Prism: One piece of 8 F prisms with bi-directional rotation, Speed adjustable
- Led ring :RGB color, present the circular rainbow flow effect, chasing, section dynamic effects etc;
- Unique Effect: Magic kaleidoscope

### Appearance

- Size: 416x356x488mm
- Weight: 22kg
- Casing: Die-cast aluminum
- Color: Black

### Work Environment

- Ambient Temp: -20°C-45°C
- IP Rated: IP65

### Certification

- CE、MET

### ILLUMINANCE AT DISTANNXE

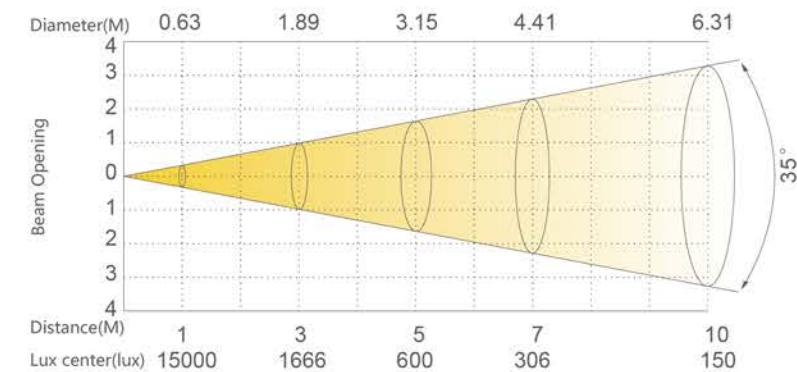
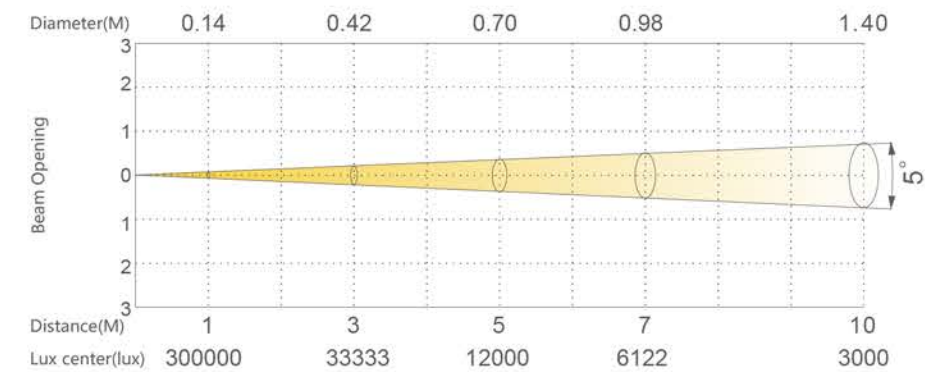



## NEPTUNE 400 WASH SS672XCEM

The NEPTUNE 400 WASH is a high efficient and lightweight IP65 LED wash moving head, with 19x20W Osram LED, special outer ring control and Individual LED pixel effect. HSIC color management system can easily to pick up any colors needed; What's more, the patented pending CCS technology makes sure the color consistence on all batches. The NEPTUNE 400 WASH is ideal tool for theme park, Amusement, landmark building, commercial plaza, outdoor performance, events etc.



### DIMENSIONS

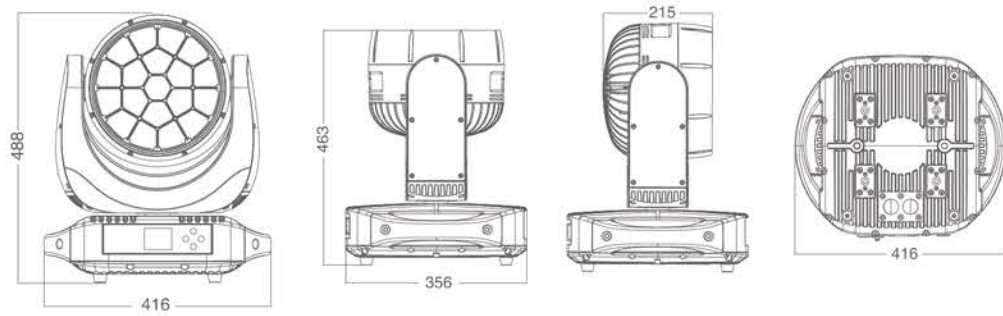

### ACCESSORIES

Accessories not included unless otherwise stated

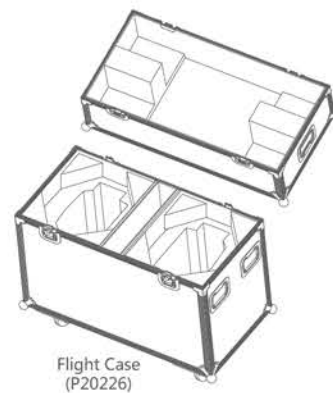

Flight Case (P20226)

### Optical system

- Light source: 19x20W (RGBW)
- Angle: 5°-35°

### Electrical Specs

- Voltage: AC100-240V,50/60Hz
- Max. Power: 400W
- Drive Current: 1.2A
- Power Connection: power in
- Signal socket: 3pin or 5pin in and out, RJ45 in and out for Art-net

### Control System

- Pan/Tilt rotation: 540°/220°
- Dimmer: 0-100%16Bit
- Cooling: Forced Convection
- Control: DMX512、RDM、ARTNET、SACN W-DMX (optional)
- Display: On board Control, Custom Mode,0-25Hz Strobe
- Con Personality: HSIC(16CHS), SSP (14CHS), TOUR (18CHS), TR16 (25CHS), CMY(19CHS), PIXEL(89CHS)
- Special: Pan/Tilt movement blackout, User-selectable pan/tilt ranges

### Effect synthetic system

- Led ring :RGB color light, can present the circular arrangement, flowing water, chasing, single point control effect

### Appearance

- Size: 416x356x488mm
- Weight: 23kg
- Casing: Die-cast aluminum
- Color: Black

### Work Environment

- Ambient Temp: -20°C-45°C
- IP Rated: IP65

### Certification

- CE、MET

### ILLUMINANCE AT DISTANCE

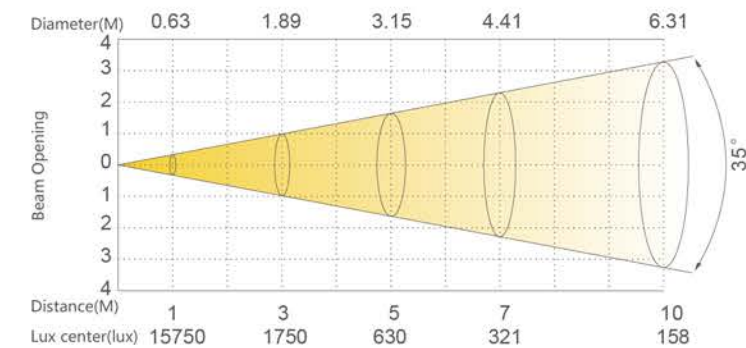
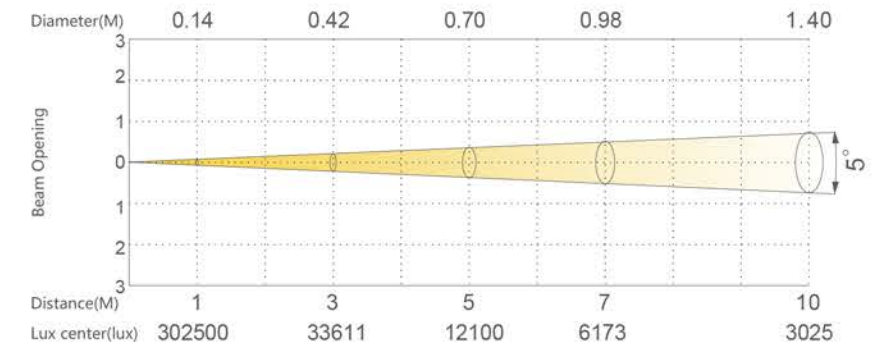



The PLUTO series represent the new era of LED moving head! It introduce the .latest developed optical technology, professional industrial design, ensure the perfect demonstration of LED lighting. This series mean of truly high efficiency and energy saving, endless colors, pure even mixing, fast and silent movement, various delicated effects. The launch of PLUTO series announce the LED movinghead step into a brand-new standard now!



## PLUTO 600 PROFILE SS660SC

PLUTO 600 PROFILE is a high-power professional LED profile moving ahead with 7°-50° Electronic zoom system. It is a kind of final version stage light, accurate and efficient motor can provide not only large pan angle and tilt angles but also with smooth and high speed. PLUTO 600 PROFILE has image-cutting system can cut out any polygon, and with zoom, focus, prism, color wheel, CMY, gobo wheels, iris, frost can supply high-quality beam colors and gobos. PLUTO 600 PROFILE is equipped with animation wheel which can create dynamic water and dynamic fire effect. PLUTO 600 PROFILE is design for the cultural center, function hall, banquet hall, and rental performance market.



To get more infos

### DIMENSIONS

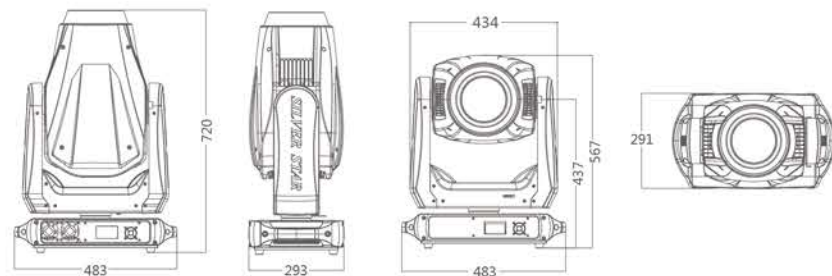

### ACCESSORIES

Accessories not included unless otherwise stated

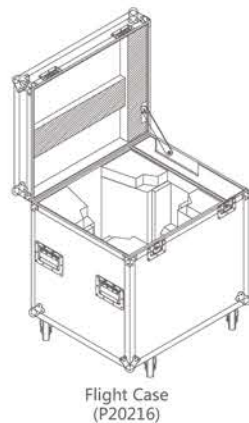

Flight Case (P20216)

### Optical system

- Light source: 600W module
- Angle: 7°-50°

### Electrical Specs

- Voltage: 100-240VAC, 50/60Hz
- Max. power: 880W
- Drive Current: 3A
- Power Connection: Power in
- Signal socket: 3pin 5pin in and out, RJ45 in and out for Art-net

### Control System

- Pan/Tilt rotation: 540°/270°(8-16bit)
- Dimmer: 0-100%16Bit
- Cooling: Forced Convection
- Control: DMX512, RDM, ARTNET
- Display: On board Control, Custom Mode, 0-25Hz Strobe
- Con Personality: STANDARD/35CHS, BASIC/33CHS,
- Special: Pan/Tilt movement blackout, User-selectable pan/tilt ranges

### Work Environment

- Ambient Temp: 0-45°C
- IP Rated: IP20

### Fixed Gobo

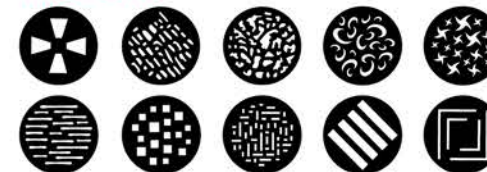

### Framing System

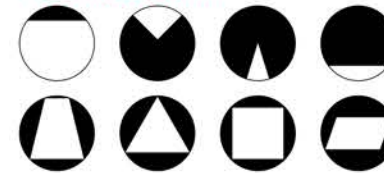

### Animation Wheel



### Effect synthetic system

- Rotating Gobo: 7 Gobos+ White, Gobo-flow effect, Gobo shake, Bi-directional rotation
- Static Gobo: 10Gobos+White, Gobo-flow effect, Gobo shake
- Colors: One color wheel (7dichroic-filters+White,Rainbow-flow effect)
- CMYK: CMYwheel, Linear CTO function
- Prism: One piece of 5 F prisms with bi-directional rotation, Speed adjustable
- Framing: 1 Framing module: 4 framing blades-45°-45° rotation ,graphics at different sizes and shapes, curtain effect.
- Iris: 5-100% linearly adjustable with macro
- Focus: Motorized linear focus
- Frost: 1 Frost filter

### Appearance

- Size: 483x282x720mm
- Weight: 34kg
- Casing: Flame-retardant plastic (V0)
- Color: Black

### Certification

- CE, MET

### Rotation Gobo

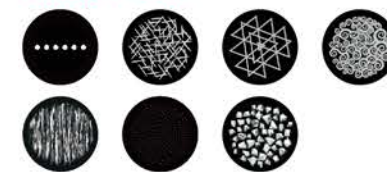

### Color



### CMY+CTO



### ILLUMINANCE AT DISTANXXE

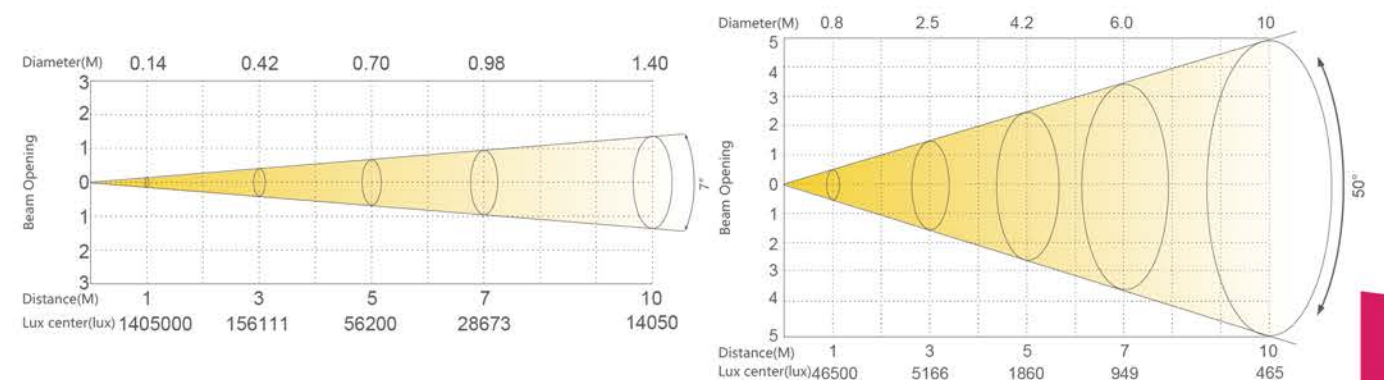



## PLUTO 600 SPOT SS661SC

PLUTO 600 SPOT is a professional high power 600W LED moving spot, incredible wide zoom 7-50°(1:7), high quality CMY color mixing and linear CTO, accurate gobo projection with fast and quiet pan/tilt movement. Adding the frost, can achieve a professional and large scale wash effect; It is an ideal product for TV, theatre, event, concert, multi-functional hall.



### DIMENSIONS

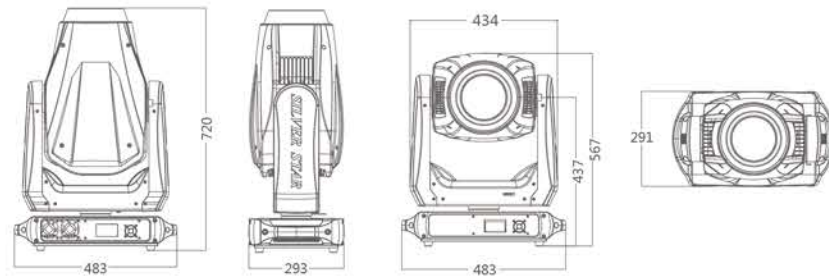

### ACCESSORIES

Accessories not included unless otherwise stated

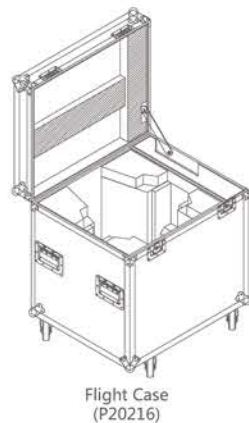

### Optical system

- Light source: 600W module
- Angle: 7°-50°

### Electrical Specs

- Voltage: 100-240VAC, 50/60Hz
- Max. power: 850W
- Drive Current: 3A
- Power Connection: Power in
- Signal socket: 3pin 5pin in and out, RJ45 in and out for Art-net

### Control System

- Pan/Tilt rotation: 540°/270°(8-16bit)
- Dimmer: 0-100%16Bit
- Cooling: Forced Convection
- Control: DMX512, RDM, ARTNET, W-DMX (optional)
- Display: On board Control, Custom Mode, 0-25Hz Strobe
- Con Personality: STANDARD/26CHS, BASIC/23CHS
- Special: Pan/Tilt movement blackout, User-selectable pan/tilt ranges

### Work Environment

- Ambient Temp: 0-45 C
- IP Rated: IP20

### Fixed Gobo

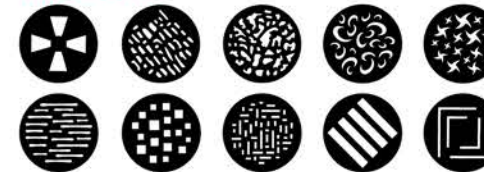

### Color

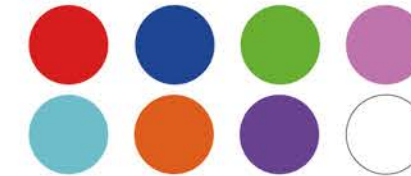

### Effect synthetic system

- Rotating Gobo: 7 Gobos+ White, Gobo-flow effect, Gobo shake, Bi-directional rotation
- Static Gobo: 10Gobos+White, Gobo-flow effect, Gobo shake
- Colors: One color wheel (7dichroic-filters+White, Rainbow-flow effect)
- CMYK: CMYwheel, Linear CTO function
- Prism: One piece of 5 F prisms with bi-directional rotation, Speed adjustable
- Iris: 5-100% linearly adjustable with macro
- Focus: Motorized linear focus
- Frost: 1 Frost filter

### Appearance

- Size: 483x282x720mm
- Weight: 32.5kg
- Casing: Flame-retardant plastic (V0)
- Color: Black

### Certification

- CE, MET

### Rotation Gobo

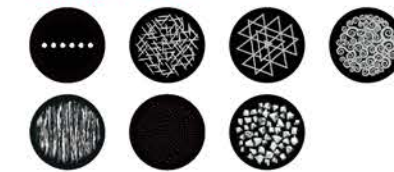

### CMY+CTO



### Animation Wheel



### ILLUMINANCE AT DISTANCE

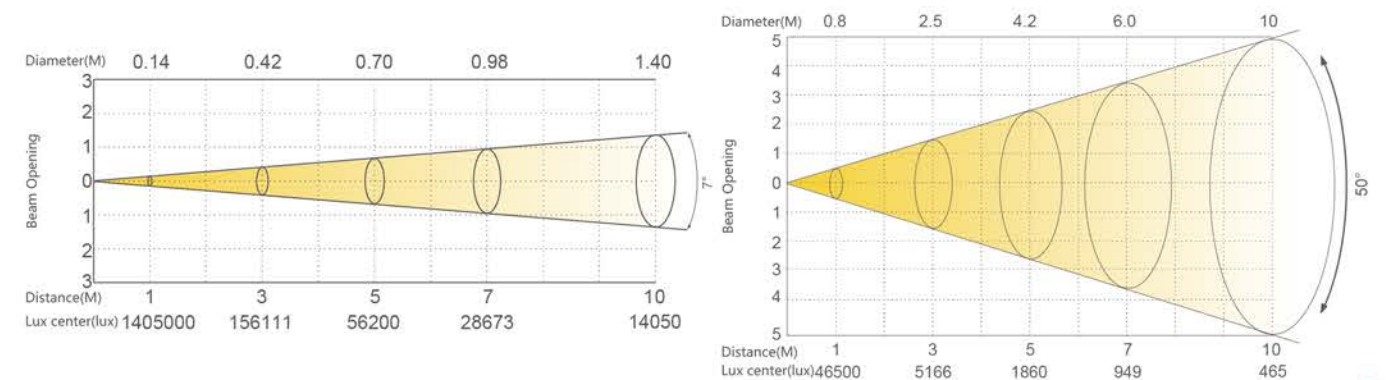



## PLUTO 600 PROFILE WASH SS664SC

The high power Moving framing wash light PROFILE WASH ,with efficiency 600W LED optic system, smooth electronic zoom (Fresnel lens 7°-62° and PC lens 3°-65°optional)Precise X/Y positioning professional performance, 2 color wheels, CMY and linear CTO, framing system for variety of cutting effects; Silver Star PLUTO 600W is a cool Moving framing wash for theatre, TV, concert hall, events and rental markets.



To get more infos

### DIMENSIONS

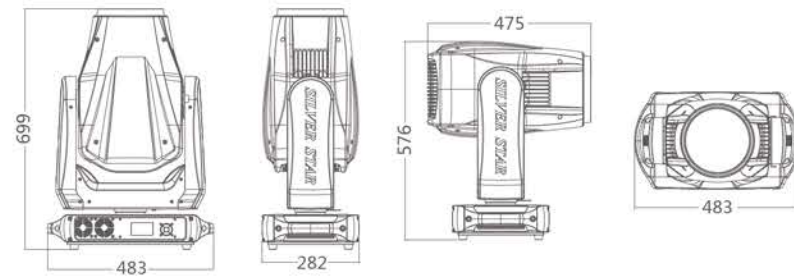

### ACCESSORIES

Accessories not included unless otherwise stated

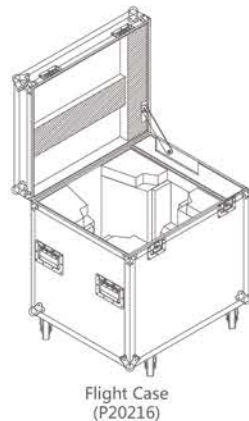

Fresnel glass lens: X40462  
Fresnel PC lens: X40463

### Optical system

- Light source: 600W White module
- Angle: Fresnel glass lens:7°-62°, Fresnel PC Lens: 3°-65°

### Electrical Specs

- Voltage: 100-240VAC, 50/60Hz
- Max. power: 800W
- Drive Current: 3A
- Power Connection: Power in
- Signal socket: 3pin 5pin in and out,RJ45 in and out for Art-net

### Control System

- Pan/Tilt rotation: 540°/270°(8-16bit)
- Dimmer: 0-100%16Bit
- Cooling: Forced Convection
- Control: DMX512, RDM, ARTNET, W-DMX (optional)
- Display: On board Control, Custom Mode, 0-25Hz Strobe
- Con Personality: STANDARD/30CHS, BASIC/27CHS
- Special: Pan/Tilt movement blackout, User-selectable pan/tilt ranges

### Color 1

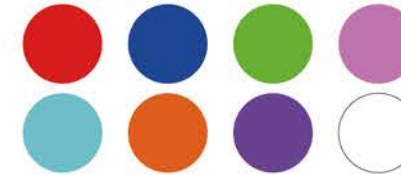

### Framing System

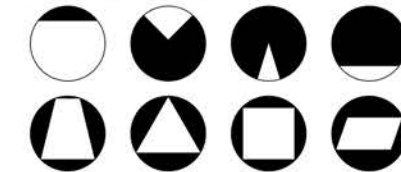

### Effect synthetic system

- Colors: Two color wheel (7dichroic-filters+White, Rainbow-flow effect).
- CMYK: CMY wheel, Linear CTO function
- Framing: 1 Framing module: 4 framing blades-45°-45° rotation ,graphics at different sizes and shapes, curtain effect.
- Iris: 5-100% linearly adjustable with macro
- Focus: Motorized linear focus

### Appearance

- Size: 483x282x699mm
- Weight: Fresnel glass lens: 32.5Kg  
Fresnel PC Lens: 31.5Kg
- Casing: Flame-retardant plastic (V0)
- Color: Black

### Work Environment

- Ambient Temp: 0-45 °C
- IP Rated: IP20

### Certification

- CE, MET

### Color 2

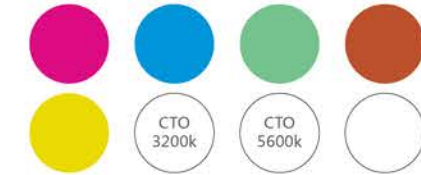

### CMY+CTO



### ILLUMINANCE AT DISTANNXE

#### Fresnel glass lens

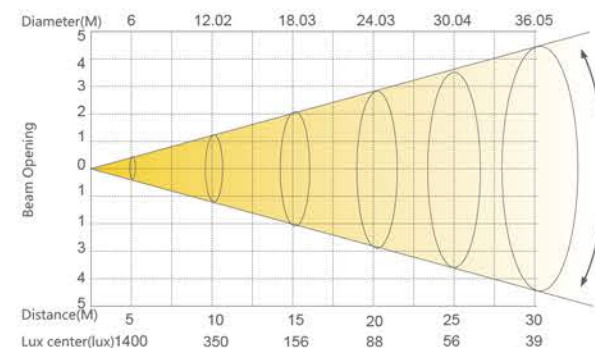
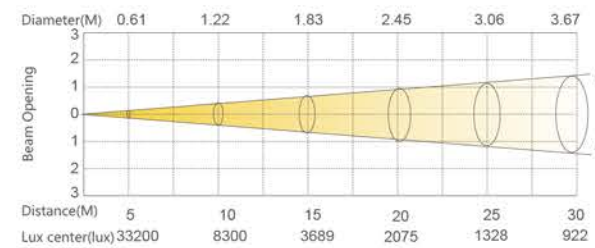

#### Fresnel PC Lens

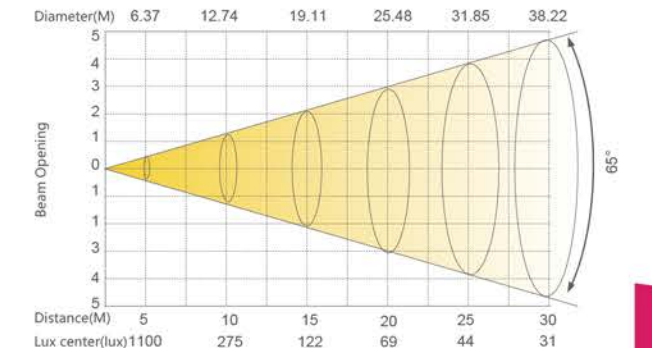
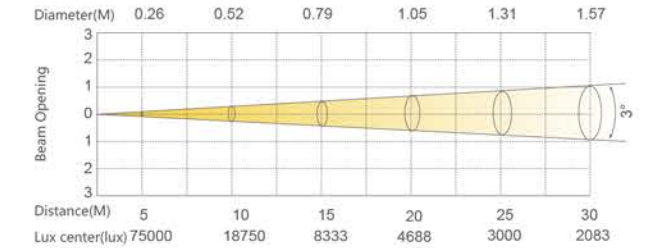



## PLUTO 600 WASH SS663SC

PLUTO 600 WASH is a high power LED moving wash, with efficiency 600W LED optic system, smooth electronic zoom (Fresnel lens 7°-62° and PC lens 3°-65° optional), precise X/Y positioning, 2 color wheel, with high quality CMY and linear CTO. It is an ideal product for TV, Theatre, Concert, events and rental market.



To get more infos

### DIMENSIONS

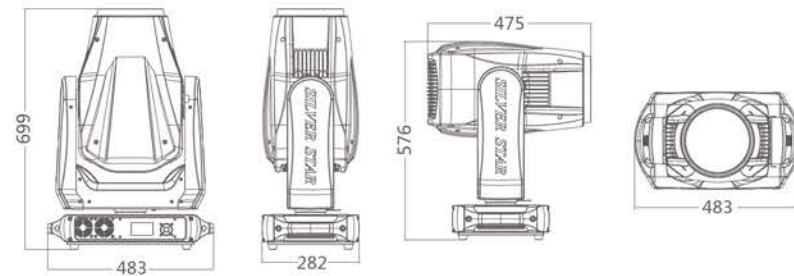

### ACCESSORIES

Accessories not included unless otherwise stated

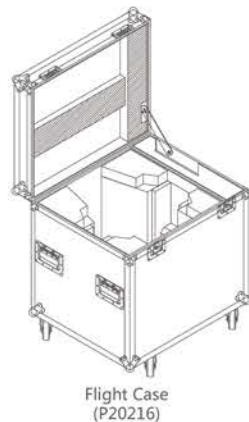

Fresnel glass lens: X40462  
Fresnel PC lens: X40463

### Optical system

- Light source: 600W White module
- Angle: Fresnel glass lens: 7°-62°, Fresnel PC Lens: 3°-65°

### Electrical Specs

- Voltage: 100-240VAC, 50/60Hz
- Max. power: 800W
- Drive Current: 3A
- Power Connection: Power in
- Signal socket: 3pin 5pin in and out, RJ45 in and out for Art-net

### Control System

- Pan/Tilt rotation: 540°/270°(8-16bit)
- Dimmer: 0-100%16Bit
- Cooling: Forced Convection
- Control: DMX512, RDM, ARTNET, W-DMX (optional)
- Display: On board Control, Custom Mode, 0-25Hz Strobe
- Con Personality: STANDARD/21CHS, BASIC/18CHS
- Special: Pan/Tilt movement blackout, User-selectable pan/tilt ranges

### Color 1

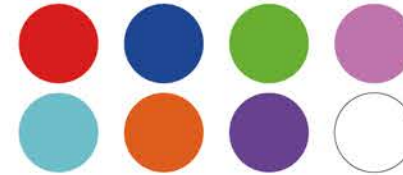

### CMY+CTO



### Effect synthetic system

- Colors: Two color wheel (7dichroic-filters+White, Rainbow-flow effect).
- CMYK: CMY wheel, Linear CTO function
- Iris: 5-100% linearly adjustable with macro
- Focus: Motorized linear focus

### Appearance

- Size: 483x282x699mm
- Weight: Fresnel glass lens: 30Kg  
Fresnel PC Lens: 29Kg
- Casing: Flame-retardant plastic (V0)
- Color: Black

### Certification

- CE, MET

### Work Environment

- Ambient Temp: 0-45°C
- IP Rated: IP20

### Color 2

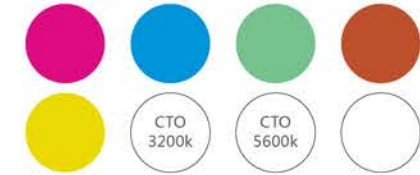

### ILLUMINANCE AT DISTANCE

#### Fresnel glass lens

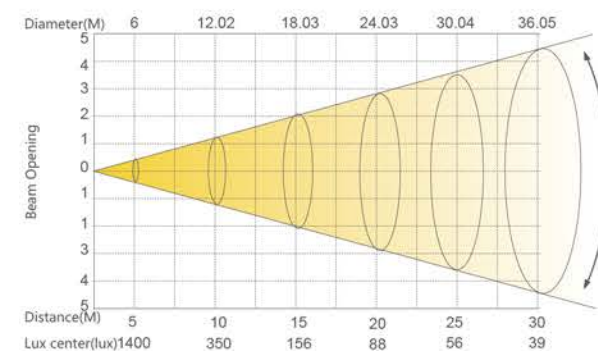
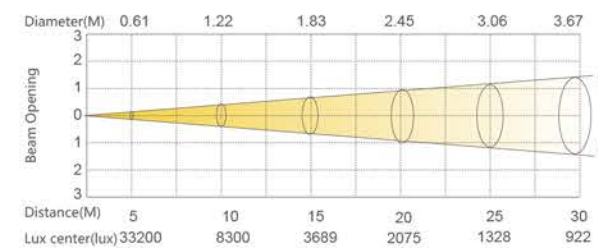

#### Fresnel PC Lens

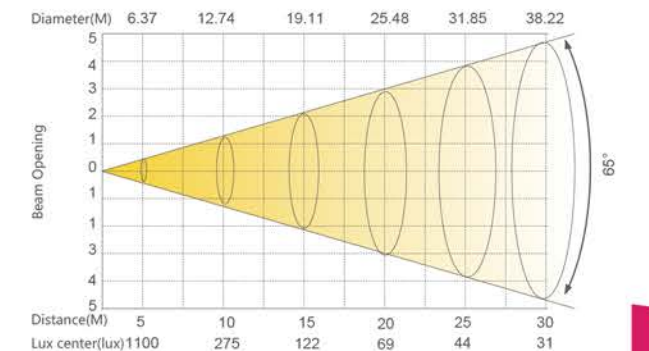
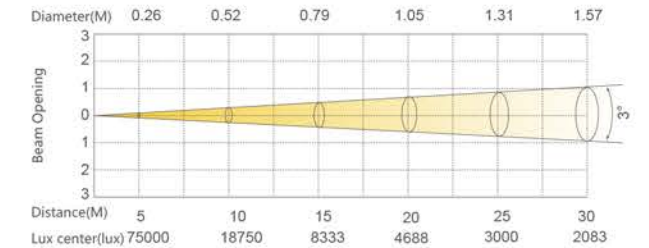



## PLUTO 350 SS659SC

PLUTO 350 is a professional LED spot moving ahead with 5°-35° Electronic zoom system. The luminance at 5 meter is 42000lx. It is a kind of final version stage light, accurate and efficient motor can provide not only large pan angle and tilt angles but also with smooth and high speed. PLUTO 350 with CMY system, zoom, focus, prism, color wheel, rotation gobo wheel, iris, frost can supply high-quality beam colors and gobos. PLUTO 350 is design for the cultural center, function hall, banquet hall, rental performance market.



To get more infos

### DIMENSIONS

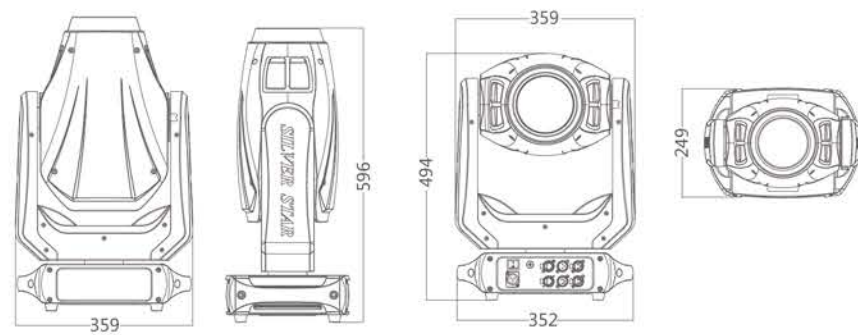

### ACCESSORIES

Accessories not included unless otherwise stated



Flight Case  
(P20197)

### Optical system

- Light source: 350W module
- Angle: 5°-35°

### Electrical Specs

- Voltage: 100-240VAC, 50/60Hz
- Max. power: 450W
- Drive Current: 4A
- Power Connection: Power in and out
- Signal socket: 3pin 5pin in and out, RJ45 in and out for Art-net

### Control System

- Pan/Tilt rotation: 540°/270°(8-16bit)
- Dimmer: 0-100%16Bit
- Cooling: Forced Convection
- Control: DMX512,RDM,ARTNET, W-DMX (optional)
- Display: On board Control, Custom Mode,0-25Hz Strobe
- Con Personality: STANDARD/25CHS,BASIC/22CHS,
- Special: Pan/Tilt movement blackout, User-selectable pan/tilt ranges

### Work Environment

- Ambient Temp: 0-45 C
- IP Rated: IP20

### Fixed Gobo



### Color

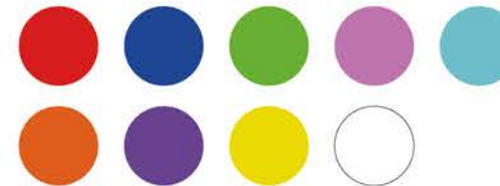

### Effect synthetic system

- Rotating Gobo: 8Gobos+White, Gobo-flow effect, Gobo shake, Bi-directional rotation
- Static Gobo: 12Gobos+White, Gobo-flow effect, Gobo shake
- Colors: CMY wheel/One color wheel(8dichroic-filters+White, Rainbow-flow effect)
- Prism: One piece of 4 prism with bi-directional rotation, Speed adjustable
- Iris: 5-100% linearly adjustable with macro
- Focus: Motorized linear focus
- Frost: 1 Frost filter

### Appearance

- Size: 359x249x596mm
- Weight: 18.5kg
- Casing: Flame-retardant plastic (V0)
- Color: Black

### Certification

- CE, MET

### Rotation Gobo

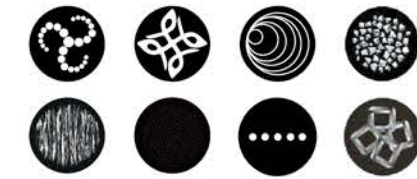

### CMY+CTO



### ILLUMINANCE AT DISTANCE

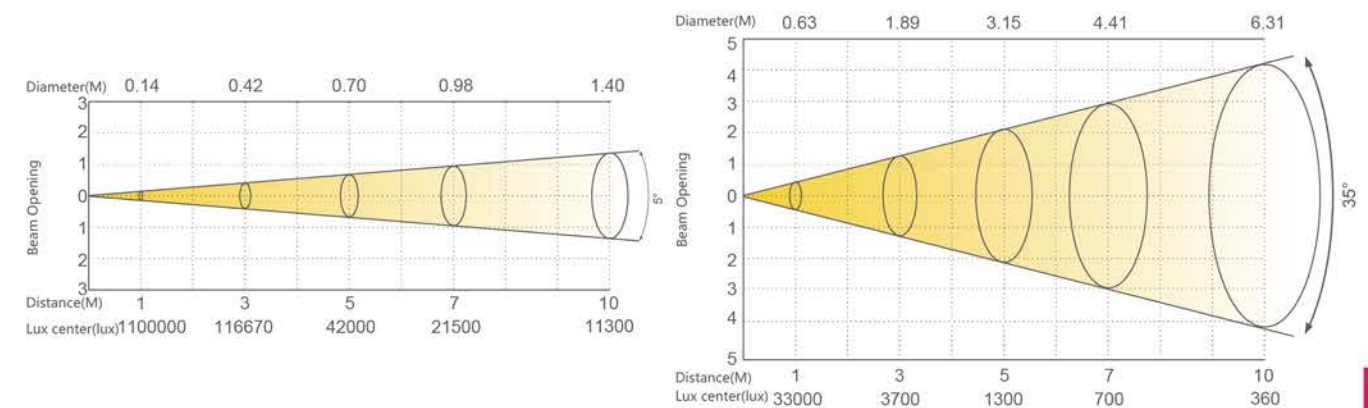



## PLUTO 300 SS657SC HD

PLUTO 300 HD set the new milestone for professional LED SPOT moving head! Its subtle design creates a compact and lightweight fixture, with incredible strong output and comprehensive functions! Rapid and silent X/Y movement; 7-40° wide and precise zoom range, intelligent auto-focusing software; Fast and smooth CMY system; Well-chosen colors, fixed and Rotating gobos wheel, frost and prism effects, what's more, the refined 16bit dimming simulate the classic halogen dimmer curve. The PLUTO 7500XS HD is born for the Rental house, TV station, Theatre, studio and concert hall applications.



To get more infos

### DIMENSIONS

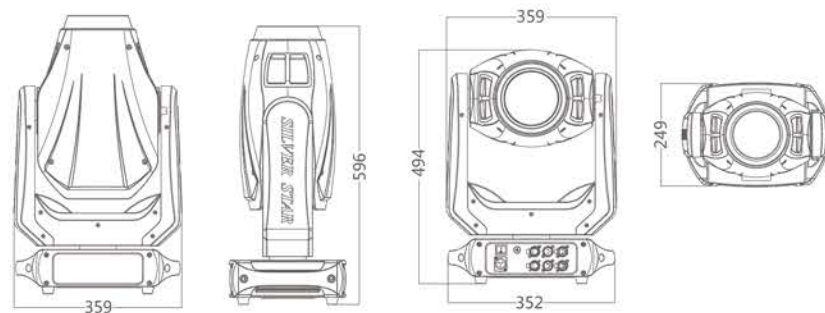

### ACCESSORIES

Accessories not included unless otherwise stated



Flight Case  
(P20197)

### Optical system

- Light source: 270W module
- Angle: 7°-40°

### Electrical Specs

- Voltage: 100-240VAC, 50/60Hz
- Max. power: 400W
- Drive Current: 4A
- Power Connection: Power in and out
- Signal socket: 3pin 5pin in and out, RJ45 in and out for Art-net

### Control System

- Pan/Tilt rotation: 540°/270°(8-16bit)
- Dimmer: 0-100%16Bit
- Cooling: Forced Convection
- Control: DMX512, RDM, ARTNET, W-DMX (optional)
- Display: On board Control, Custom Mode, 0-25Hz Strobe
- Con Personality: STANDARD/24CHS, BASIC/21CHS,
- Special: Pan/Tilt movement blackout, User-selectable pan/tilt ranges

### Work Environment

- Ambient Temp: 0-45°C
- IP Rated: IP20

### Effect synthetic system

- Rotating Gobo: 7Gobos+White, Gobo-flow effect, Gobo shake, Bi-directional rotation
- Static Gobo: 10Gobos+White, Gobo-flow effect, Gobo shake
- Colors: CMY wheel/One color wheel(7 dichroic-filters+ White, Rainbow-flow effect)
- Prism: One piece of 3F prism with bi-directional rotation, Speed adjustable
- Iris: 5-100% linearly adjustable with macro
- Focus: Motorized linear focus
- Zoom: Motorized linear Zoom
- Frost: 1 Frost filter

### Appearance

- Size: 359x249x596mm
- Weight: 18kg
- Casing: Flame-retardant plastic (V0)
- Color: Black

### Certification

- CE, MET

### Fixed Gobo



### Color

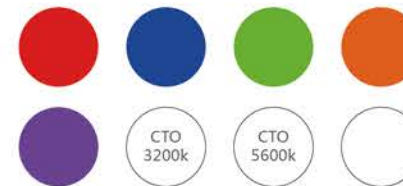

### Rotation Gobo

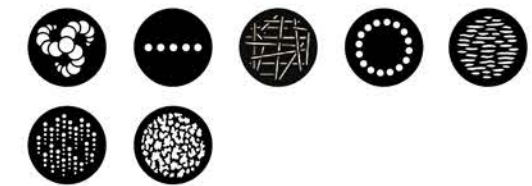

### CMY



### ILLUMINANCE AT DISTANCE

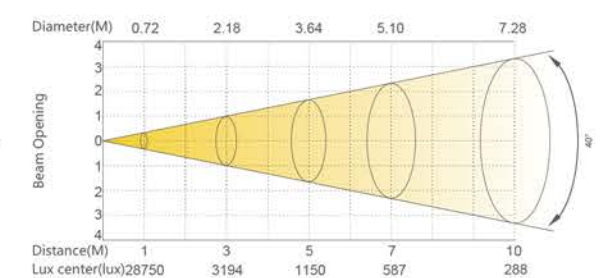
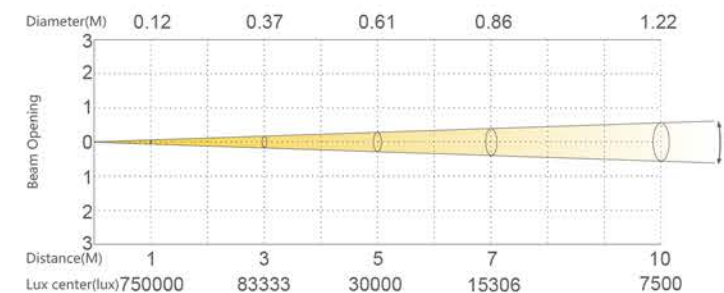



## PLUTO 250 SS662SC

PLUTO 250 Medium-sized professional LED hybrid moving ahead with 3-35° Electronic zoom system. It is a kind of final version stage light, accurate and efficient motor can provide not only large pan angle and tilt angles but also with smooth and high speed. PLUTO 250 with zoom, focus, prism, color wheel, rotation gobo wheel, iris, can supply high-quality beam and gobos. PLUTO 250 is design for the cultural center, function hall, banquet hall, and rental performance market.



To get more infos

### DIMENSIONS

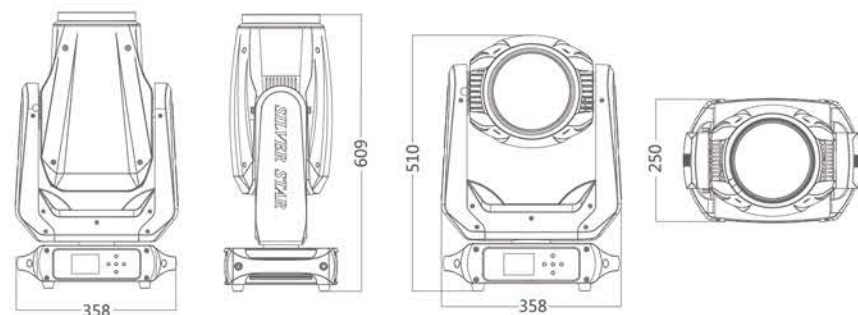

### ACCESSORIES

Accessories not included unless otherwise stated



Flight Case (P20197)

### Optical system

- Light source: 250W module
- Angle: 3°-35°

### Electrical Specs

- Voltage: 100-240VAC, 50/60Hz
- Max. power: 320W
- Drive Current: 3A
- Power Connection: Power in and out
- Signal socket: 3pin 5pin in and out

### Control System

- Pan/Tilt rotation: 540°/270°(8-16bit)
- Dimmer: 0-100%16Bit
- Cooling: Forced Convection
- Control: DMX512, RDM, W-DMX (optional)
- Display: On board Control, Custom Mode,0-25Hz Strobe
- Con Personality: STANDARD/19CHS, BASIC/16CHS,
- Special: Pan/Tilt movement blackout, User-selectable pan/tilt ranges

### Work Environment

- Ambient Temp: 0-45°C
- IP Rated: IP20

### Effect synthetic system

- Rotating Gobo: 8 Gobos+ White, Gobo-flow effect, Gobo shake, Bi-directional rotation
- Static Gobo: 12 Gobos+ White, Gobo-flow effect, Gobo shake
- Colors: One color wheel(8 dichroic-filters+ White, Rainbow-flow effect)
- Prism: One piece of 5 F prism with bi-directional rotation, Speed adjustable
- Focus: Motorized linear focus

### Appearance

- Size: 358x250x609mm
- Weight: 19kg
- Casing: Flame-retardant plastic (V0)
- Color: Black

### Certification

- CE, MET

### Fixed Gobo



### Rotation Gobo



### Color



### ILLUMINANCE AT DISTANNXE

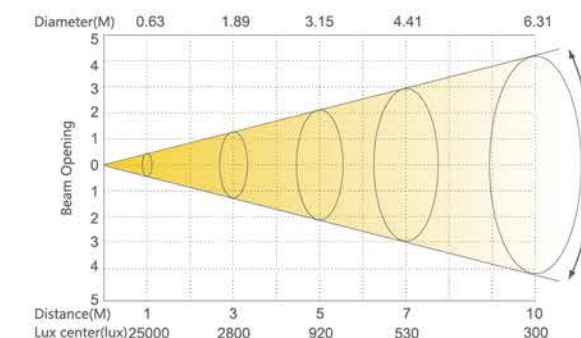
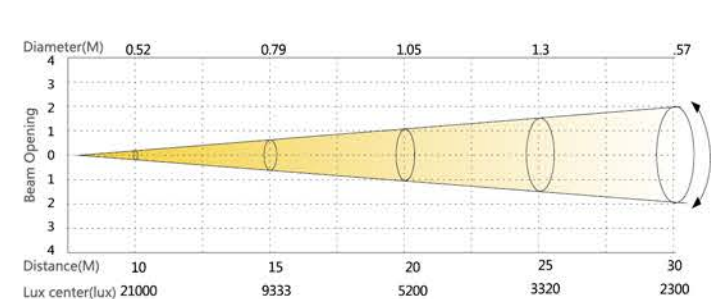



## PLUTO 200 SS658SC

PLUTO 200 With Compact and lightweight design. It is a kind of final version stage light, accurate and efficient motor can provide not only large pan angle and tilt angles but also with smooth and high speed. PLUTO 200 with zoom, focus, prism, color wheel, rotation gobo wheel, iris, can supply abundant high-quality colors and gobos. PLUTO 200 is design for the cultural center, function hall, banquet hall, and rental performance market.



To get more infos

### DIMENSIONS

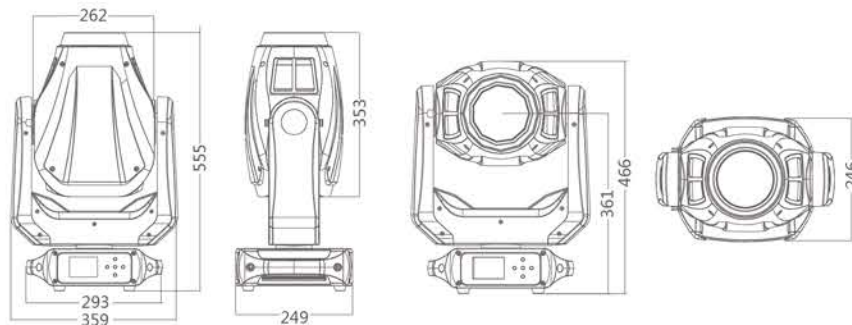

### ACCESSORIES

Accessories not included unless otherwise stated

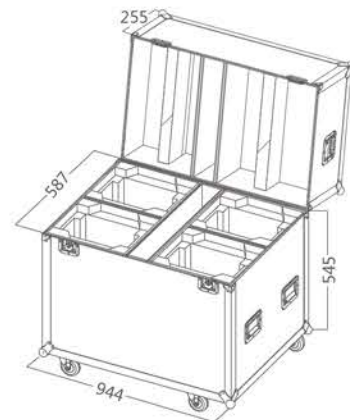

Flight Case  
(P20176)

### Optical system

- Light source: 200W module
- Angle: 10°-35°

### Electrical Specs

- Voltage: 100-240VAC, 50/60Hz
- Max. power: 280W
- Drive Current: 3A
- Power Connection: Power in and out
- Signal socket: 3pin 5pin in and out

### Control System

- Pan/Tilt rotation: 540°/270°(8-16bit)
- Dimmer: 0-100%16Bit
- Cooling: Forced Convection
- Control: DMX512, RDM, W-DMX (optional)
- Display: On board Control, Custom Mode,0-25Hz Strobe
- Con Personality: STANDARD/20CHS, BASIC/17CHS,
- Special: Pan/Tilt movement blackout, User-selectable pan/tilt ranges

### Work Environment

- Ambient Temp: 0-45°C
- IP Rated: IP20

### Effect synthetic system

- Rotating Gobo: 7 Gobos+ White, Gobo-flow effect, Gobo shake, Bi-directional rotation
- Static Gobo: 10 Gobos+ White, Gobo-flow effect, Gobo shake
- Colors: One color wheel(7 dichroic-filters+ White, Rainbow-flow effect)
- Prism: One piece of 3 F prism with bi-directional rotation, Speed adjustable
- Iris: 5-100% linearly adjustable with macro
- Focus: Motorized linear focus
- Frost: 1 Frost filter

### Appearance

- Size: 359x249x555mm
- Weight: 16.5kg
- Casing: Flame-retardant plastic (V0)
- Color: Black

### Certification

- CE、MET

### Fixed Gobo

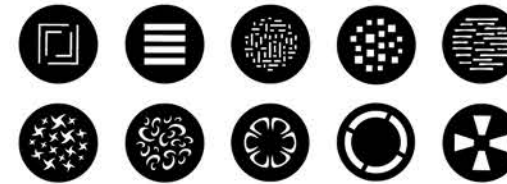

### Rotation Gobo

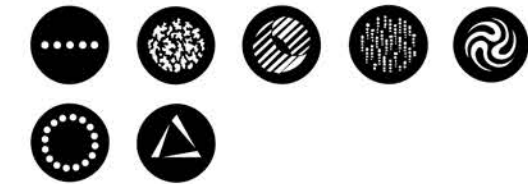

### Color



### ILLUMINANCE AT DISTANNXE

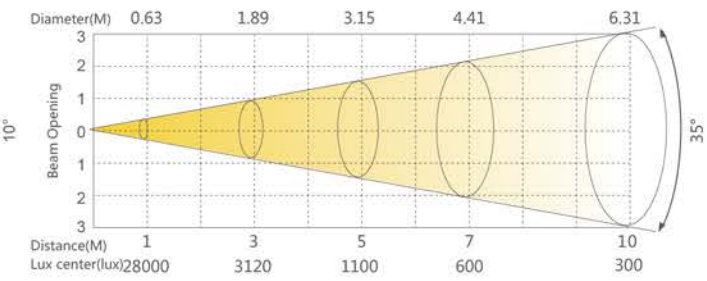
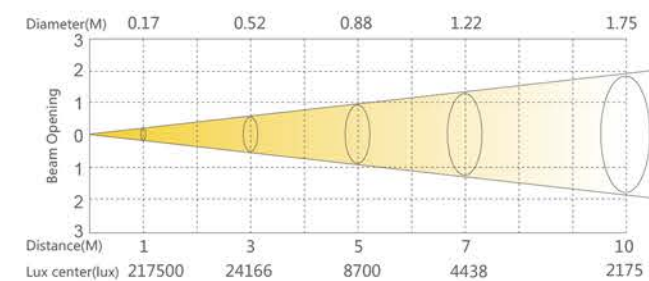



## PLUTO 4000XE SS656XCE

Zooming from 4.5° to 36°, PLUTO 4000XE is a professional high-power moving light for wash and beam. It can also be used as an effect light for perfect individual pixel control. Loaded with 12 pcs of latest 40W RGBW (4 in 1) LEDs and special optics design, it enjoys higher efficiency in lighting. Applied with intelligent color-mixing system, HSIC, any color needed can be easily mixed in high quality. With excellent performance, it is applicable to different kinds of places, such as concert, TV station, and theater and rental market.

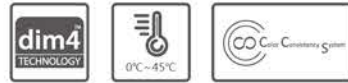

To get more infos

### DIMENSIONS

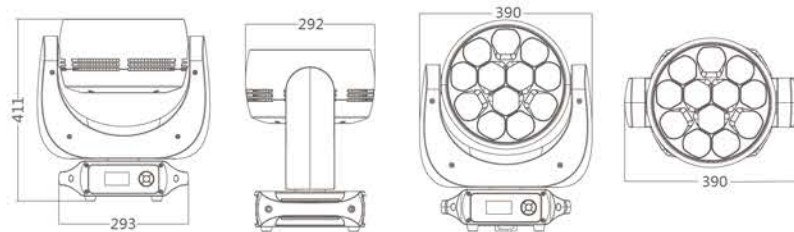

### ACCESSORIES

Accessories not included unless otherwise stated

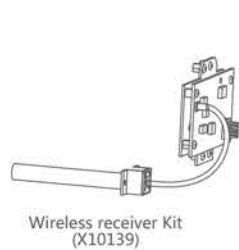

Wireless receiver Kit (X10139)

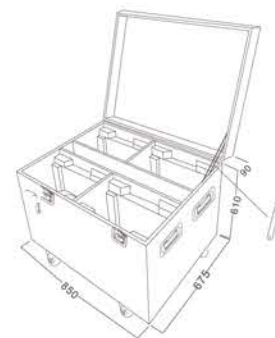

Flight Case (P20176)

lithium battery (1160000482)

### Optical system

- Light source: 12x40W (RGBW),(RGBA optional)
- Angle: 4.5°-36°

### Electrical Specs

- Voltage: 100-240VAC, 50/60Hz
- Max. power: 460W
- Drive Current: 2.5A
- Power Connection: Anti-loose power socket in the out
- Signal socket: 3pin or 5pin in and out,RJ45 in and out for Art-net

### Control System

- Pan/Tilt rotation: 540°/270°(8-16bit)
- Dimmer: 0-100%16Bit
- Cooling: Forced Convection
- Control: DMX512, RDM, Art Net, W-DMX (optional)
- Display: On board Control, Custom Mode,0-25Hz Strobe
- Con Personality: HSIC (13CHS) ,PERSON1 (13CHS) , PERSON2 (21CHS) ,PIXEL(57CHS),CMY(15CHS)
- Special: Pan/Tilt movement blackout, User-selectable pan/tilt ranges

### Appearance

- Size: 390x292x411mm
- Weight: 12.5kg
- Casing: Flame-retardant plastic (V0)
- Color: Black

### Work Environment

- Ambient Temp: 0-45°C
- IP Rated: IP20

### Certification

- CE, MET

### ILLUMINANCE AT DISTANNXE

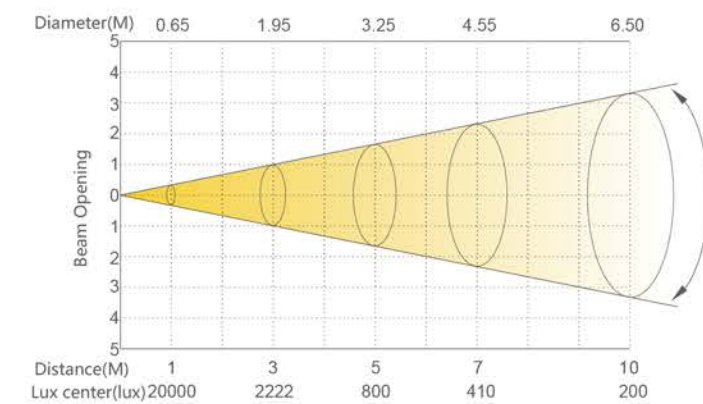
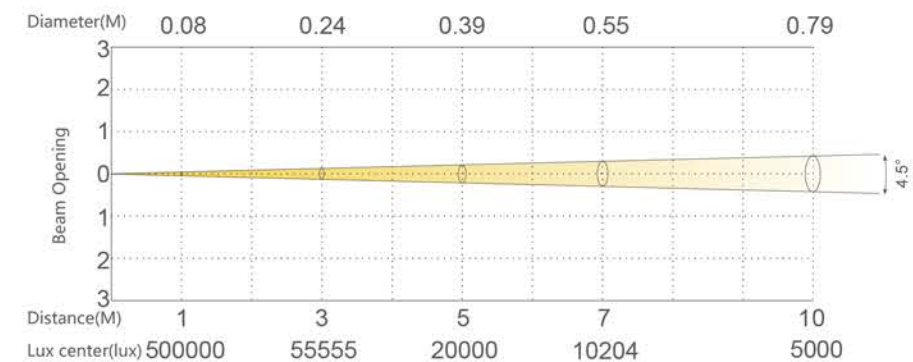



## PLUTO 2000XE SS646XCE

PLUTO 2000XE is the new generation LED moving wash! Using 7x40W RGBW LED, high efficient optic, applying the HSIC color management system. Individual pixel control. Incredible zoom range 4.5°-36°, either creates tight/strong beam or massive wash effects. With the lightweight /compact design, PLUTO 2000XE is ideal wash light for professional rental / concert / TV applications.



To get more infos

### Optical system

- Light source: 7x40W (RGBW),(RGBA optional)
- Angle: 4.5°-36°

### Electrical Specs

- Voltage: 100-240VAC, 50/60Hz
- Max. power: 300W
- Drive Current: 2.5A
- Power Connection: Power in and out
- Signal socket: 3pin or 5pin in and out, RJ45 in and out for Art-net

### Control System

- Pan/Tilt rotation: 540°/270°(8-16bit)
- Dimmer: 0-100%16Bit
- Cooling: Forced Convection
- Control: DMX512, RDM, Art Net, W-DMX (optional)
- Display: On board Control, Custom Mode, 0-25Hz Strobe
- Con Personality: HSIC(13CHS),PERSON1(12CHS),PERSON2(20CHS),PIXEL(37CHS),CMY(14CHS)
- Special: Pan/Tilt movement blackout, User-selectable pan/tilt ranges

### Appearance

- Size: 375x302x293mm
- Weight: 9.3kg
- Casing: Flame-retardant plastic (V0)
- Color: Black

### Work Environment

- Ambient Temp: 0-45°C
- IP Rated: IP20

### Certification

- CE, MET

## DIMENSIONS

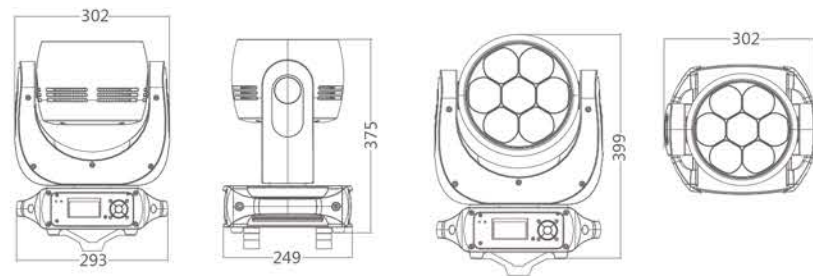

## ACCESSORIES

Accessories not included unless otherwise stated

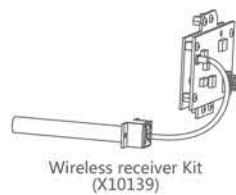

Wireless receiver Kit (X10139)

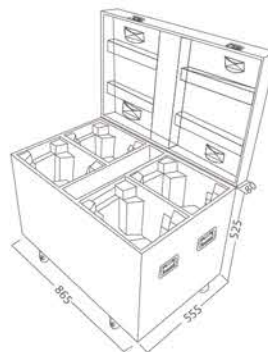

Flight Case (P20165)

lithium battery (116000482)

## ILLUMINANCE AT DISTANCE

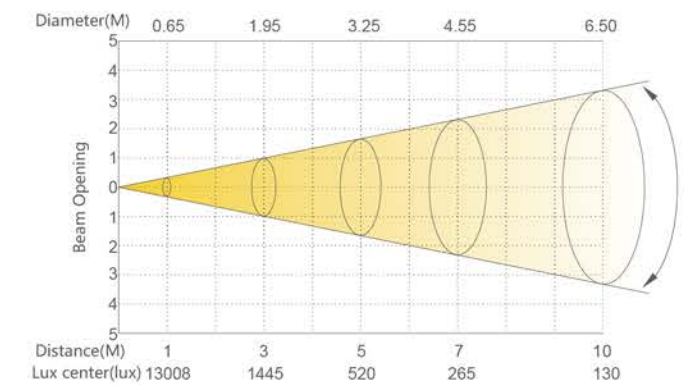
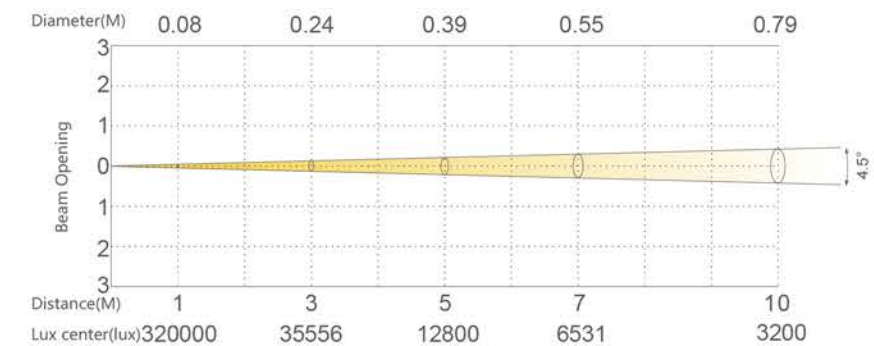



## PLUTO 800XE SS636XCE

The PLUTO 800XE create the new vision for LED moving wash; It applying the latest 40W RGBW optical technology, smooth and precise zoom system from 4.5-36°, homogenous color mixing, individual pixel control, extremely fast X/Y; The design is fashioned, compact and lightweight, suitable for various applications as TV station, concert, rental, hall, banquet.



To get more infos

### Optical system

- Light source : 3x40W (RGBW),(RGBA optional)
- Angle : 4.5°-36°

### Electrical Specs

- Voltage: 100-240VAC, 50/60Hz
- Max. power: 140W
- Drive Current: 2.5A
- Power Connection: Power in and out
- Signal socket: 3pin 5pin in and out,RJ45 in for Art-net

### Control System

- Pan/Tilt rotation: 540°/270°(8-16bit)
- Dimmer: 0-100%16Bit
- Cooling: Forced Convection
- Control: DMX512, RDM, Art Net, W-DMX (optional)
- Display: On board Control, Custom Mode, 0-25Hz Strobe
- Con Personality: HSIC(13CHS),PERSON1 (13CHS),PERSON2(21CHS),PIXEL (21CHS), CMY (15CHS)
- Special: Pan/Tilt movement blackout,User-selectable pan/tilt ranges

### Appearance

- Size : 338x260x185mm
- Weight : 6.2kg
- Casing : Flame-retardant plastic (V0)
- Color : Black

### Work Environment

- Ambient Temp : 0-45°C
- IP Rated : IP20

### Certification

- CE、MET

## DIMENSIONS

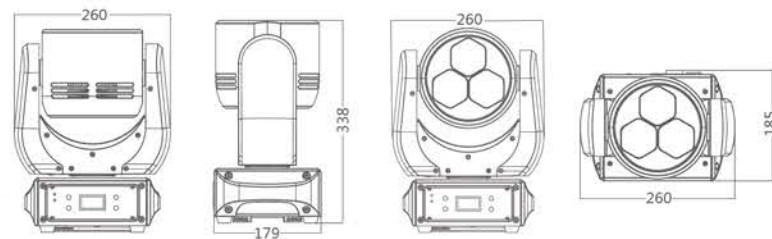

## ACCESSORIES

Accessories not included unless otherwise stated

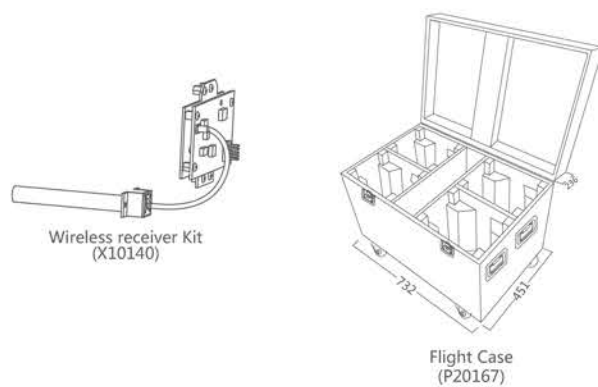

## ILLUMINANCE AT DISTANCE

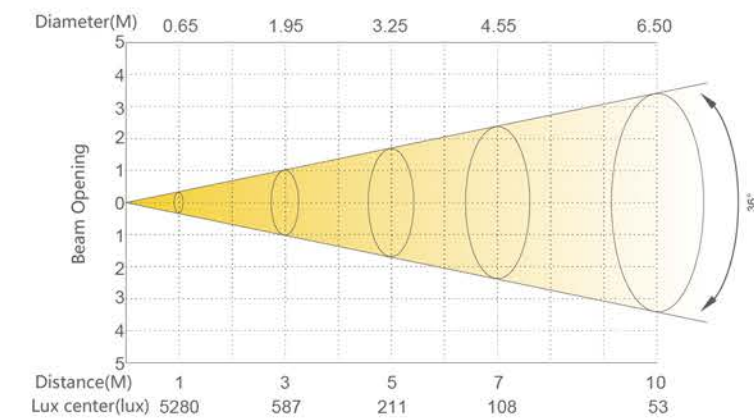
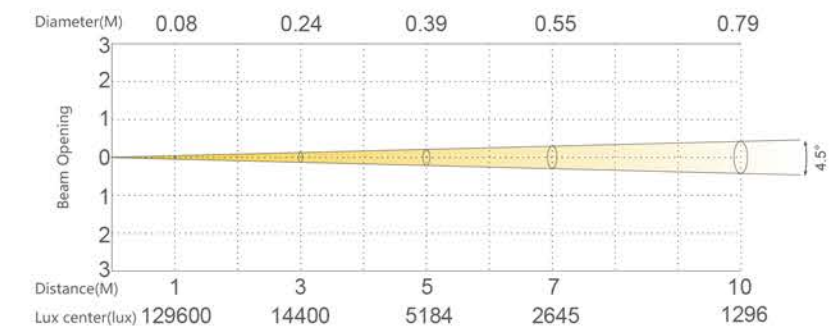



The CYAN products are developed to the highest quality, design and performance standards. CYAN combines the forefront of LED technology with advanced optics and mechanical engineering to ensure that the lighting design is able to achieve full potential. CYAN moving heads with cutting-edge LED technology demonstrate that the revolution in production lighting is in full swing.



## CYAN 12000XCE MK4 SS644XCE

The CYAN 12000XCE MK4 is a rapid moving head wash fixture. Combined with versatile 8-40deg zoom. The addition of 6-section control means that dynamic effects are easily created when multiple fixtures are used.



To get more infos

### Optical system

- Light source 37x20W (RGBW)
- Angle 8°-40°

### Electrical Specs

- Voltage: 100-240VAC,50/60Hz
- Max. Power: 570W
- Drive Current: 1000mA
- Power Connection: Power in/out
- Signal socket: 3pin 5pin in and out

### Control System

- Pan/Tilt rotation: 540°/ 270° (8-16bit)
- Dimmer: 0-100% 16Bit
- Cooling: Forced Convection
- Control: DMX512
- Display: On board Control , Custom Mode , 0-25Hz Strobe
- Con Personality: PERSON1(10CHS) , PERSON2(21CHS) , PERSON3(8CHS) , PERSON4(25CHS) , PERSON5(58CHS) , PERSON6(21CHS)
- Special: Pan/Tilt movement blackout, User-selectable pan/tilt ranges

### Appearance

- Size: 410x310x396mm
- Weight: 16.5kg
- Casing: Flame-retardant plastic(V0)
- Color: Black

### Work Environment

- Ambient Temp: 0-45°C
- IP Rated: IP20

### Certification

- CE, MET

## DIMENSIONS

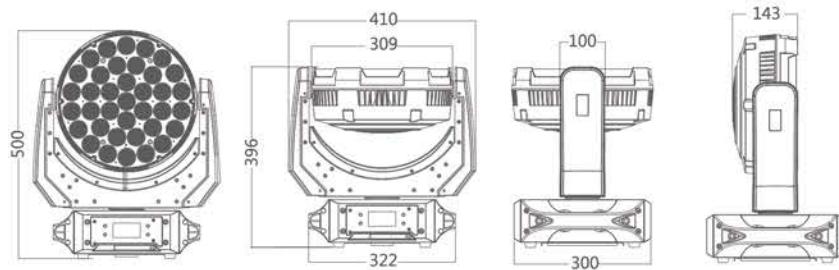

## ACCESSORIES

Accessories not included unless otherwise stated

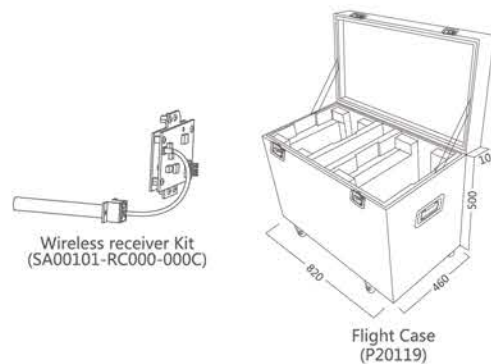

## ILLUMINANCE AT DISTANCE

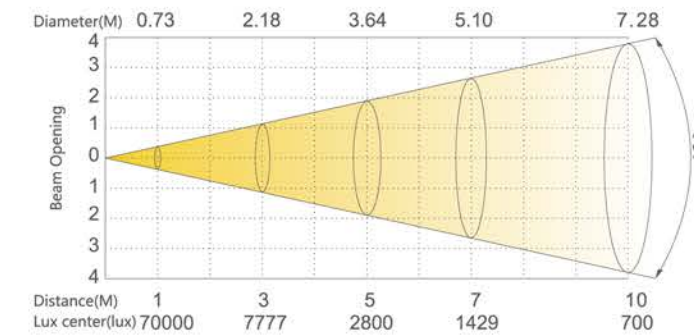
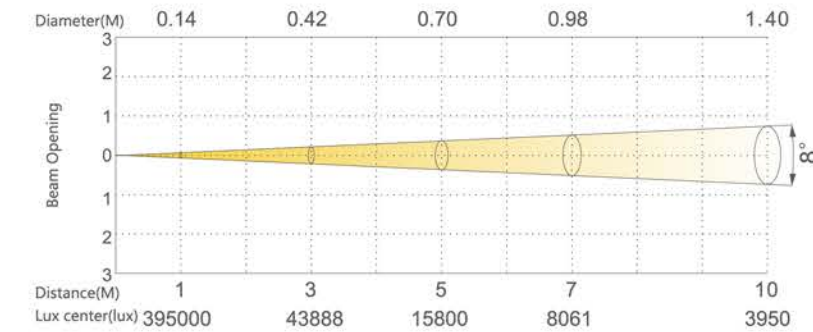



## CYAN 6000XCE MK4 SS631XCE

The CYAN 6000XCE MK4 is a compact and rapid moving head wash fixture. Combined with a versatile 8 to 40 deg zoom. The addition of 3-section control means that dynamic effects are easily created when multiple fixtures are used.



To get more infos

### Optical system

- Light source: 19x20W (RGBW)
- Angle: 8°-40°

### Electrical Specs

- Voltage: 100-240VAC,50/60Hz
- Max. Power: 350W
- Drive Current: 1000mA
- Power Connection: Power in/out
- Signal socket: 3pin 5pin in and out

### Control System

- Pan/Tilt rotation: 540°/ 270° (8-16bit)
- Dimmer: 0-100% 16Bit
- Cooling: Forced Convection
- Control: DMX512
- Display: On board Control , Custom Mode , 0-25Hz Strobe
- Con Personality: PERSON1(10CHS) , PERSON2(21CHS) , PERSON3(8CHS) , PERSON4(21CHS) , PERSON5(34CHS)
- Special: Pan/Tilt movement blackout, User-selectable pan/tilt ranges

### Appearance

- Size: 348x270x341mm
- Weight: 10kg
- Casing: Flame-retardant plastic(V0)
- Color: Black

### Work Environment

- Ambient Temp: 0-45°C
- IP Rated: IP20

### Certification

- CE, MET

## DIMENSIONS

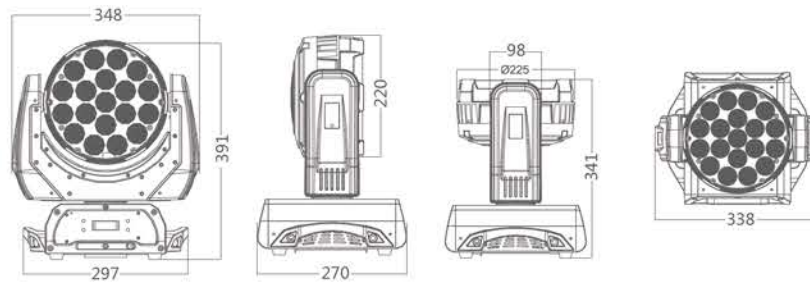

## ACCESSORIES

Accessories not included unless otherwise stated

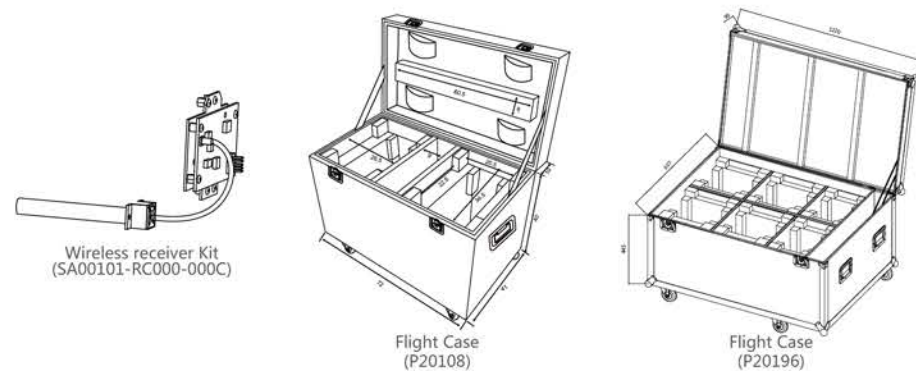

## ILLUMINANCE AT DISTANCE

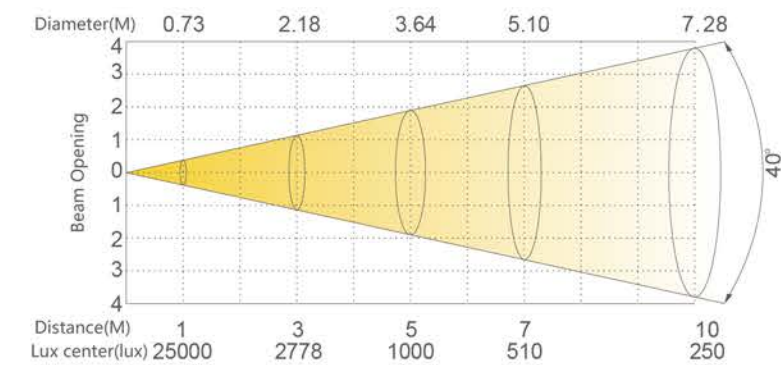
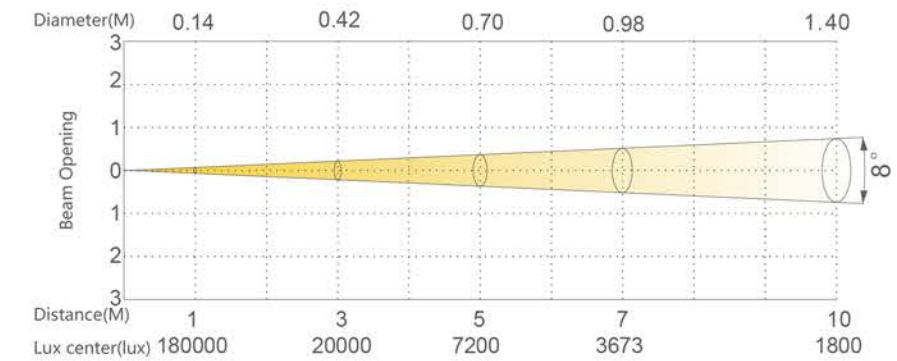



The STAGER series of products has been engineered as a premium line of lighting fixtures specifically focusing on theater and TV lighting applications. The STAGER concept of light Quality engineering has driven the possibilities and expectation in the lighting industry to new levels. Designed around original concepts and extensive innovations, the STAGER series is "the coming" that has been anticipated.



## AURORA 150 HEX SS820XHM

AURORA 150 HEX is an innovative 6in1 LED stage wash light, with classic one big homogeneous lens optic, excellent color mixing, HSIC system makes color mixing simple and easy; Precise pre-set CCT 1800-8000K, high CRI >90. It is an ideal dream tool for TV, theater, opera, studio, exhibition, Motor Show, multi-functional hall and so on.



To get more infos

### Optical system

- Light source : 150W (RGBALC)
- CCT : 1800K-8000K
- CRI : ≥90Ra
- CQS : >90
- Angle : 16° ( 25°optional )

### Electrical Specs

- Voltage : AC100-240V , 50/60Hz
- Max. Power : 143W
- Drive Current : 1A
- Power Connection : Power in/out
- DMX XLR : DMX in/out

### Control System

- Dimmer : 0-100% 16Bit
- Cooling : Forced Convection
- Control : DMX512、 RDM
- Display : On board Control , Custom Mode , 0-25Hz Strobe
- Con Personality : Basic ( 3CHS ) 、 CLR ( 6CHS ) 、 SSP ( 9CHS ) 、 TOUR ( 13CHS ) 、 TR16 ( 20CHS )

### Appearance

- Size : 320x217x418mm
- Weight : 6.5kg
- Casing : : Die-cast aluminum
- Color : Black

### Work Environment

- Ambient Temp : -20°C-45°C
- IP Rated : IP65

### Certification

- CE、 MET

## DIMENSIONS

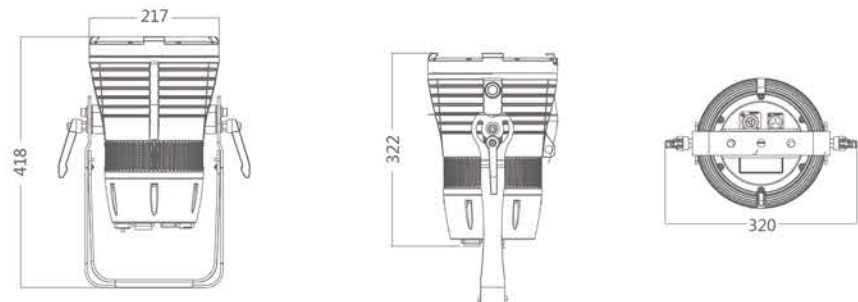

## ILLUMINANCE AT DISTANCE

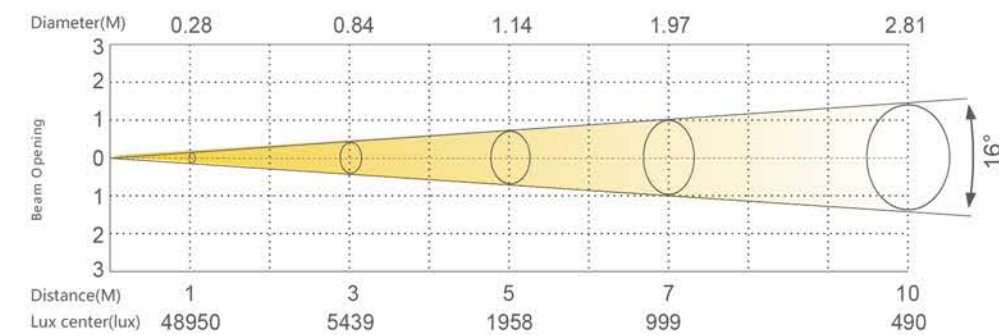

## ACCESSORIES

Accessories not included unless otherwise stated

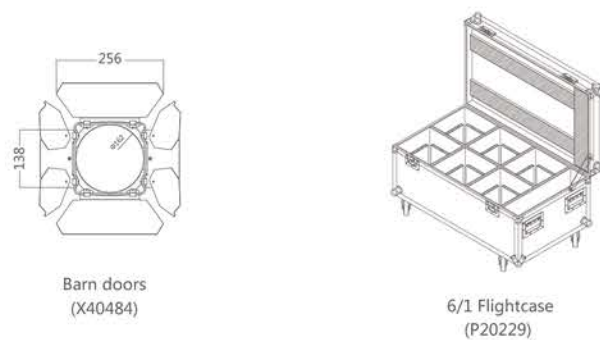



## AURORA 150 TW/TC SS820TWM/TCM

AURORA 150 TW/TC is using innovational 150W LED module, Tungsten and Daylight for optional, CRI>90Ra, support for DMX512 and RDM, perfect for the installation. It is an ideal Par for TV, studio, exhibition, multi-functional hall, theater, opera, and so on.



To get more infos

### Optical system

- Light source : 150W LED
- CCT : 3200K, 5600K
- CRI : ≥90Ra
- CQS : >90
- Angle : 16° ( 25°optional )

### Electrical Specs

- Voltage : AC100-240V , 50/60Hz
- Max. Power : 143W
- Drive Current : 1A
- Power Connection : Power in/out
- DMX XLR : DMX in/out

### Control System

- Dimmer : 0-100% 16Bit
- Cooling : Forced Convection
- Control : DMX512, RDM
- Display : On board Control , Custom Mode , 0-25Hz Strobe
- Con Personality : UNO(1CHS), DOS(2CHS), VW.D(3CHS), VW.F(6CHS), STD.P(4CHS)

### Appearance

- Size : 320x217x418mm
- Weight : 6.5kg
- Casing : : Die-cast aluminum
- Color : Black

### Work Environment

- Ambient Temp : -20°C-45°C
- IP Rated : IP65

### Certification

- CE, MET

## DIMENSIONS

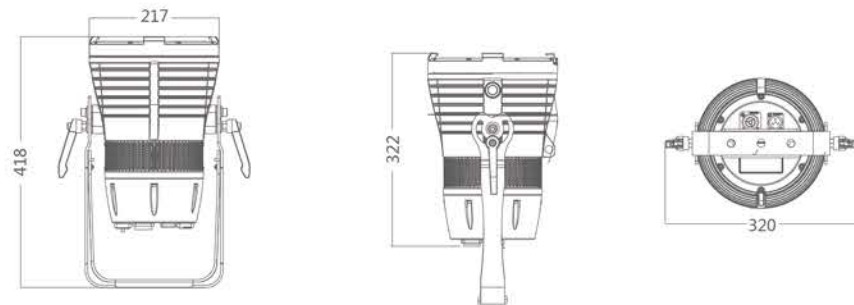

## ACCESSORIES

Accessories not included unless otherwise stated

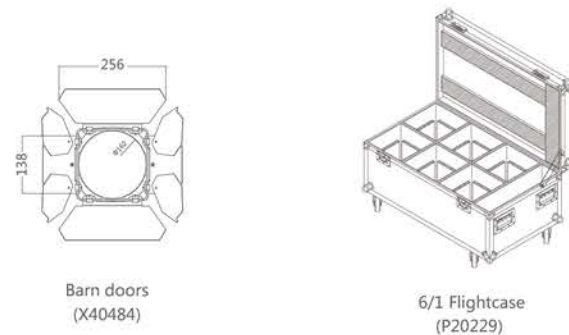

Barn doors  
(X40484)

6/1 Flightcase  
(P20229)

## ILLUMINANCE AT DISTANCE

### SS820TWM

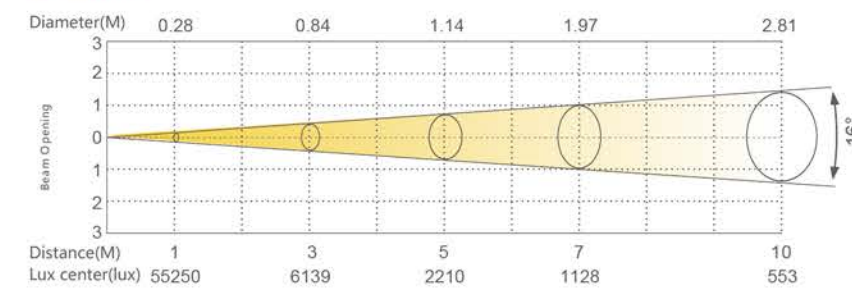

### SS820TCM

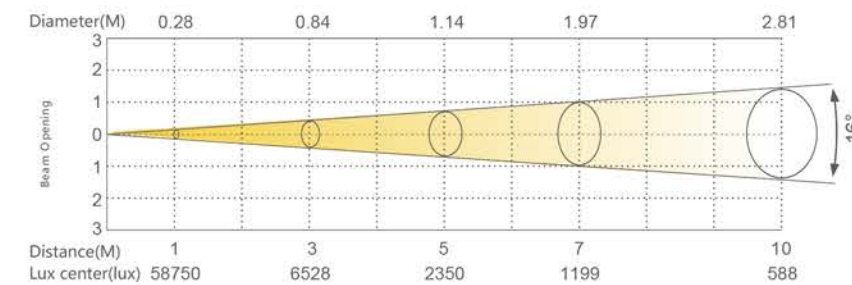

## ECLIPSE MINI SS817SW/SC

ECLIPSE MINI using new LED technology, clear image, Projection bright and even light, it is light weight and compact fixture. Suitable for Museums, galleries, hotels, shopping malls etc.



To get more infos



### Optical system

- Light source : 10W
- CCT : 3200K、5600K
- CRI : ≥90Ra
- CQS : >90
- Angle : 19°-36° ( Manual control )

### Electrical Specs

- Voltage : 100-240VAC,50/60Hz
- Max. power : 13W
- Drive Current : 1A
- Power Connection : Power in

### Control System

- Dimmer : 0-100%16Bit
- Cooling : Direct Convection
- Control : Dimming Pack Control、0-10V

### Appearance

- Size : 305x113x109mm
- Weight : 1.6kg
- Casing : Die-cast aluminum
- Color : Black

### Work Environment

- Ambient Temp : 0°C-45°C
- IP Rated : IP20

### Certification

- CE、MET

### DIMENSIONS

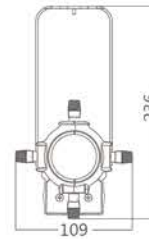
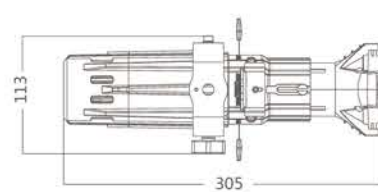

### ACCESSORIES

Accessories not included unless otherwise stated

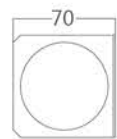

Gelmedia frame  
( 2441013923 )



Gobo holder  
( 1340500819 )

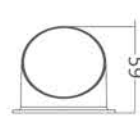

Glare-shield  
( X40281 )

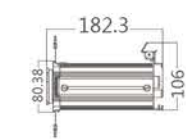

Zoom cylinder(19°-36°)  
( X40291 )



The cutting drum  
( X40293 )

### ILLUMINANCE AT DISTANCE

#### SS817SW

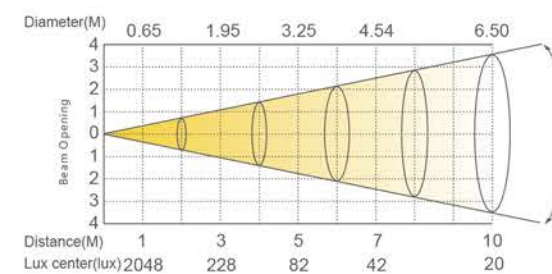
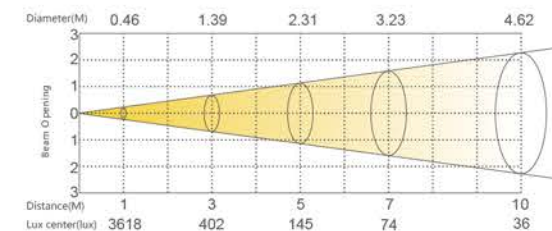
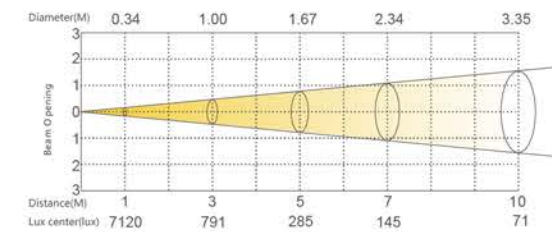

#### SS817SC

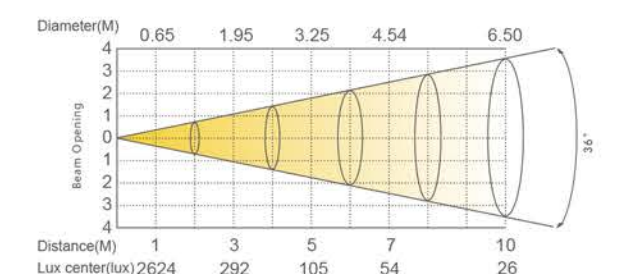
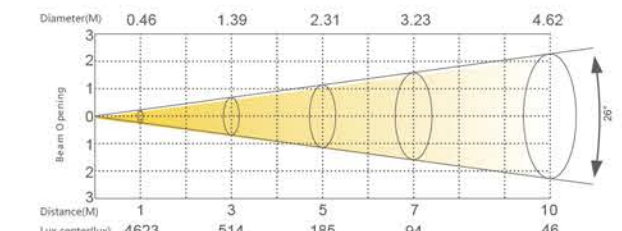
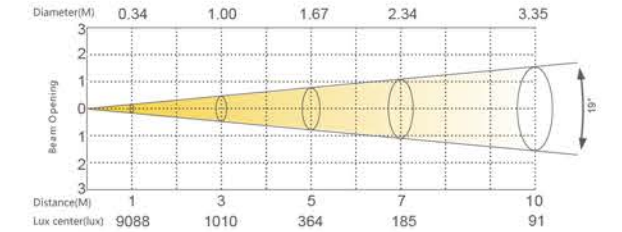



## mobi ECLIPSE MINI SS818SW/SC

The mobi ECLIPSE MINI is a mini battery Ellipsoidal. Apply with high-performance Lithium battery, smart manual dimmer, no more need any power/DMX cables. It is the perfect lighting tool for the temporary exhibition, show, banquets etc.



To get more infos

### Optical system

- Light source : 10W LED
- CCT : 3200K, 5600K
- CRI :  $\geq 90Ra$
- CQS :  $> 90$
- Angle : 19°-36° ( Manual control )

### Electrical Specs

- Voltage : 100-240VAC,50/60Hz
- Max. Power : 13W
- Drive Current : 1A
- Power Connection : Power in

### Battery Info

- Pwer Cable : 13000mA
- Run time : 5-12hrs(depend on output level)
- Charging Cycle : 5hrs

### Control System

- Cooling : Direct Convection
- Dimmer : Manual

### Appearance

- Size : 341x130x133mm
- Weight : 1.7kg
- Casing : Die-cast aluminum
- Color : Black

### Work Environment

- Ambient Temp : 0°C-45°C
- IP Rated : IP20

### Certification

- CE, MET

## DIMENSIONS

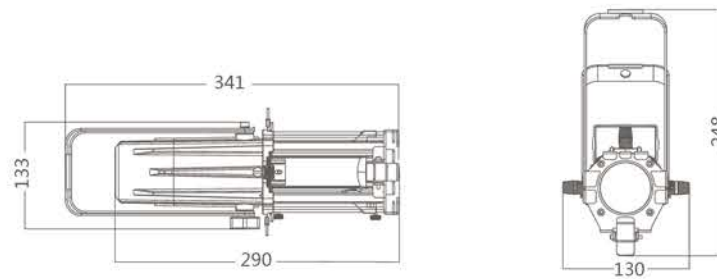

## ACCESSORIES

Accessories not included unless otherwise stated

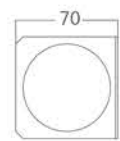

Gel media frame  
(2440103923)



Gobo holder  
(1340500819)

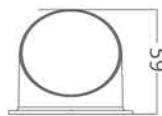

Glare-shield  
(X40281)

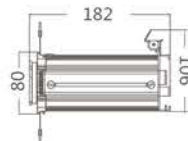

Zoom barrel(19°-36°)  
(X40291)



Charging suitcase  
(P20140)

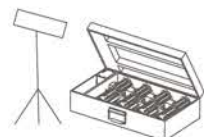

Charging suitcase tripod  
(P20143)



European : (1160000510)  
American : (1160000511)

## ILLUMINANCE AT DISTANNXE

### SS818SW

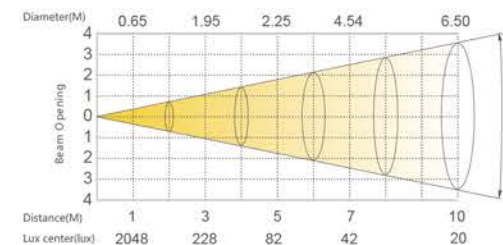
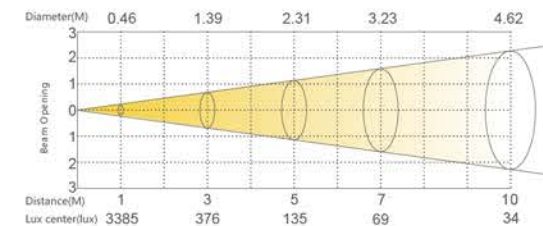
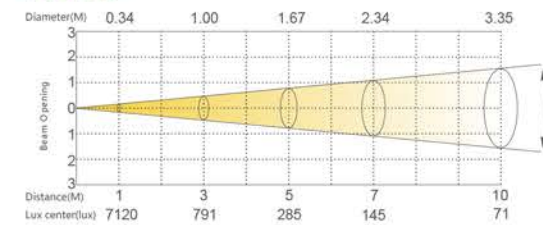

### SS818SC

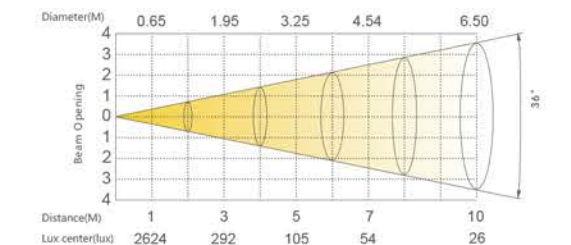
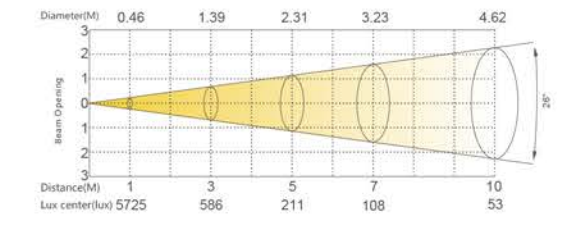
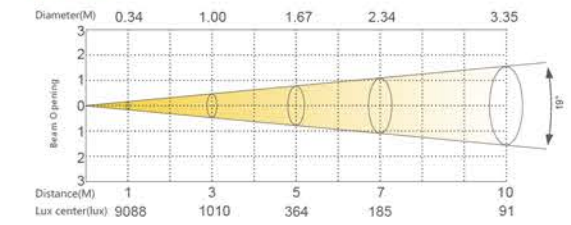



## ECLIPSE MINI HD SS867SW HD/SC HD

ECLIPSE MINI HD uses new technology LED, with crystal clear and even light projection, DMX control and support for RDM, small body with multiple functions, perfect for ancient museums, exhibitions, gallery, hotels, stores and small to medium theatres.



## ECLIPSE MINI HDD SS867SW HDD/SC HDD

ECLIPSE MINI HDD specifically design for replacing the traditional lamp Ellipsoidal, which control by the dimmer pack, with 0-100% dimming of thyristor, dimming smooth and no jitter, illuminate clear images, showing a bright and uniform beam, incorporate a variety of functions into lamps, light and free. It's designed for mobile performances, ancient cultural exhibition halls, galleries, wedding performances, hotels, shopping malls, small studios and other small and medium-sized venues.



### DIMENSIONS

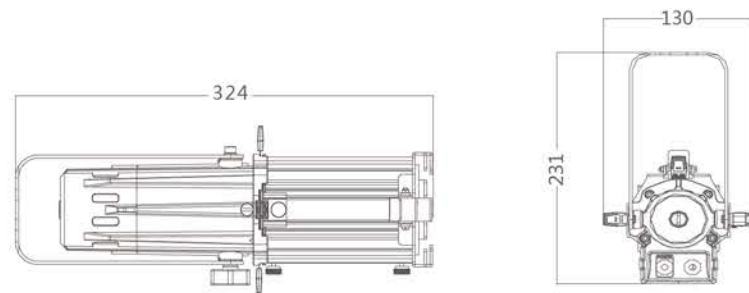

### ACCESSORIES

Accessories not included unless otherwise stated

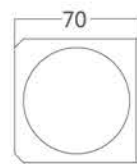

Gel media frame  
(2440103923)



Gobo holder  
(1340500819)

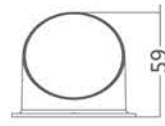

Glare - shield  
(X40281)

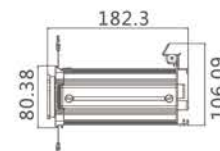

Zoom cylinder(19°-36°)  
(X40291)

### Optical system

#### SS867SW HD/SC HD

- Light source : 40W COB
- CCT : 3200K, 5600K
- CRI : ≥90Ra
- CQS : >90
- Angle : 19°-36° ( Manual control )

#### SS867SW HDD/SC HDD

- 40W COB
- 3200K, 5600K
- ≥90Ra
- >90
- 19°-36° ( Manual control )

### Appearance

- Size : 324x130x231mm
- Weight : 1.2kg
- Casing : Die-cast aluminum
- Color : Black

### Electrical Specs

- Voltage : 100-240VAC ,
- Max. power : 25W
- Drive Current : 0.5A
- Power Connection : Power in
- DMX XLR : DMX Spliter, IN/OUT

- 100-120VAC, 220-240VAC
- 25W
- 0.5A
- Power in

### Work Environment

- Ambient Temp : 0°C-45°C
- IP Rated : IP20

### Certification

- CE, MET

### Control System

- Dimmer : 0-100% 16Bit / Manual
- Cooling : Direct Convection
- Control : DMX, RDM

- 0-100%16Bit / Manual
- Direct Convection
- Dimming Pack Control

### ILLUMINANCE AT DISTANNXE

#### SS867SW

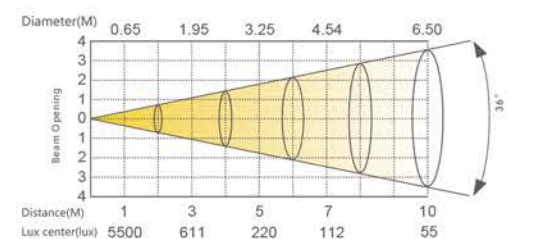
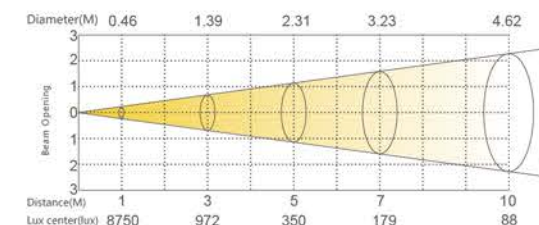
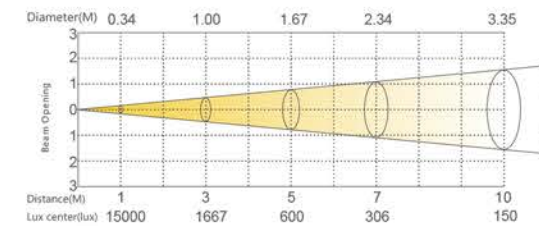

#### SS867SC

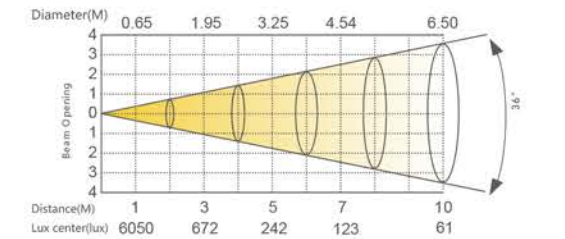
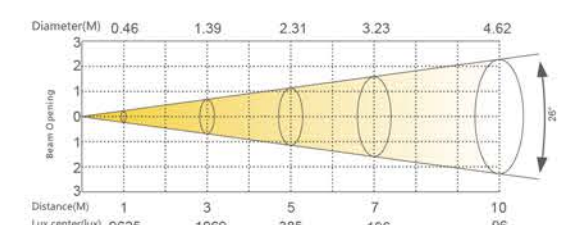
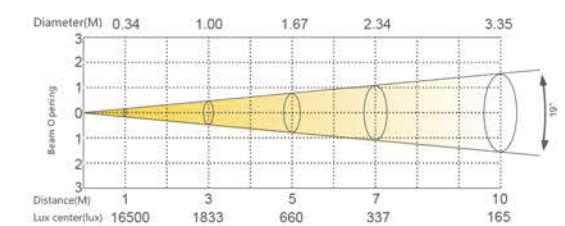



## ECLIPSE 750 HD SS827SW HD/SC HD

The ECLIPSE 750 HD is a new professional with high density integrated source, 50% brighter than the 1st great successful version, can match exactly professional lens with different degree. Shaping, logo projection is crystal clear, color rendering >90, perfect for theatre, studio, banquet halls and TV stations.



To get more infos

## ECLIPSE D750 HD SS827SW HDD/SC HDD

The ECLIPSE D750 HD specifically design for replacing the traditional lamp Ellipsoidal, which controlled by the dimmer pack; It fully match with previous SCR (Silicon Controlled Rectifier) controller, and the DMX512 signal, dimming smooth, no shading. Intelligent power management system can automatically recognize the DMX 512 Protocol and SCR. 50% brighter than the 1st successful version, color rendering >90, with compact structure, professional industrial design, it is truly energy saving fixture.



To get more infos



### DIMENSIONS

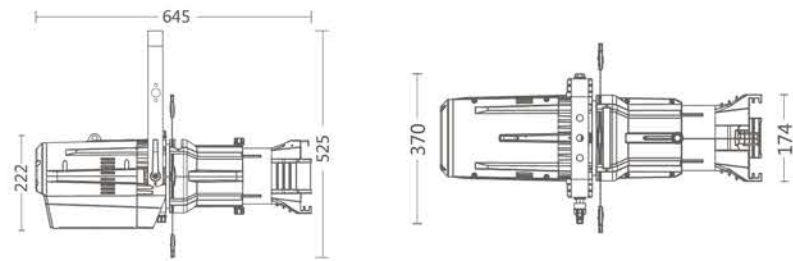

### ACCESSORIES

Accessories not included unless otherwise stated

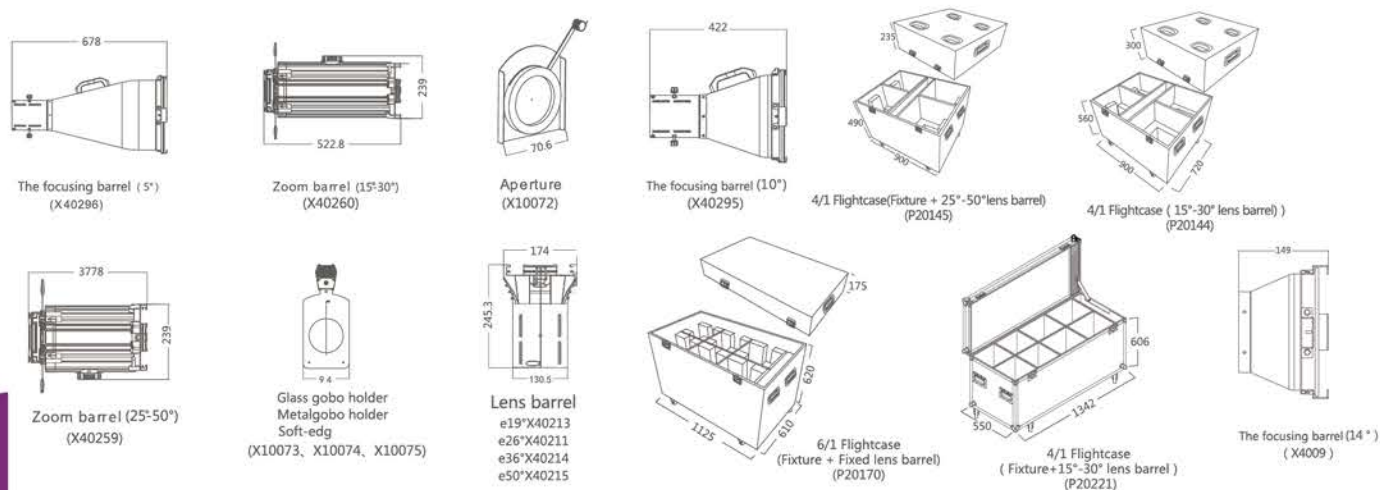

### Optical system

- Light source : 250W LED
- CCT : 3200K, 5600K
- CRI : ≥90Ra
- CQS : >90
- Angle : 5°/10°/19°/26°/36°/50°/15°-30°/25°-50°

### Electrical Specs

- Voltage : 100-240VAC, 50/60Hz
- Max. power : 250W
- Drive Current : 3.3A
- Power Connection : Power in/out
- DMX XLR : DMX in/out

### Control System

- Dimmer : 0-100%16Bit
- Cooling : Forced Convection
- Control : DMX512, [RDM, Dimming Pack Control (SS27SW HDD/SC HDD)]
- Display : On board Control, 0-25Hz Strobe
- Con Personality : UNO(1CH), DOS(2CHS), STD.P(3CHS)

### Appearance

- Size : 645x370x525mm
- Weight : 9.6kg
- Casing : Die-cast aluminum
- Color : Black

### Work Environment

- Ambient Temp : 0°C-45°C
- IP Rated : IP20

### Certification

- CE, MET

### ILLUMINANCE AT DISTANCE

#### SS827SW HD/SW HDD

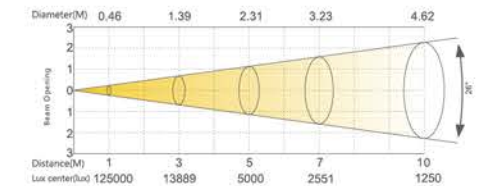
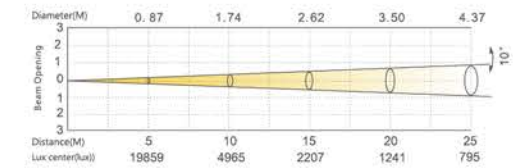
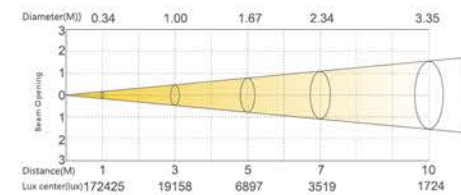
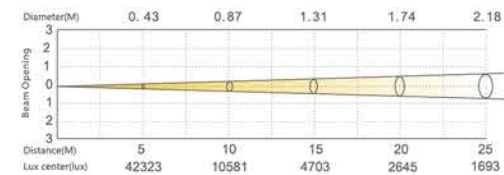

#### SS827SC HD/SC HDD

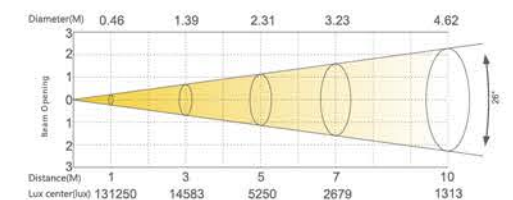
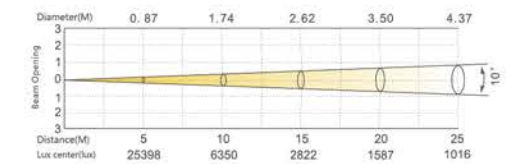
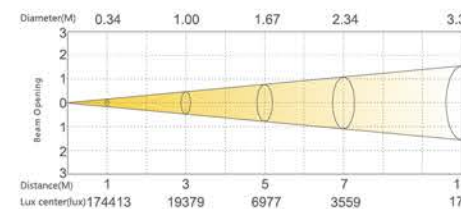
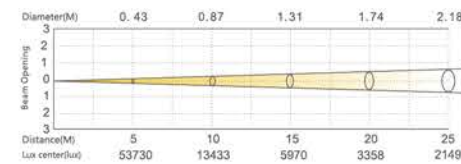



## ECLIPSE 1000 RGBAL SS847XAL

The ECLIPSE 1000 RGBAL is using the innovative 5 colors optic design. It comes with intelligent HSIC color management system, can easily pick up all colors you need. With precise preset 16 common colors, 2700K-8000K CCT, the perfect dimming curve, and the crystal-clear projection, and also it compatible with all our existing popular lenses. The ECLIPSE 1000 RGBAL is designed for the professional theatre / opera / rental / show applications!



To get more infos

### Optical system

- Light source : 250W LED
- CCT : 3200K, 5600K
- CRI :  $\geq 90Ra$
- CQS :  $> 90$
- Angle : 5°/10°/19°/26°/36°/50°/15-30°/25°-50°

### Electrical Specs

- Voltage : 100-240VAC,50/60Hz
- Max. power : 300W
- Drive Current : 1.5A
- Power Connection : Power in/out
- DMX XLR : DMX in/out

### Control System

- Dimmer : 0-100%16Bit
- Cooling : Forced Convection
- Control : DMX512, RDM
- Display : On board Control, 0-25Hz Strobe
- Con Personality : HSIC(8CHS) , SDO(6CHS) , SIMPLE(8CHS) , COLOR 8BIT(11CHS) , COLOR 16BIT(17CHS)

### Appearance

- Size : 700x301x233mm
- Weight : 10.3kg
- Casing : Die-cast aluminum
- Color : Black

### Work Environment

- Ambient Temp : 0°C-45°C
- IP Rated : IP20

### Certification

- CE, MET

## DIMENSIONS

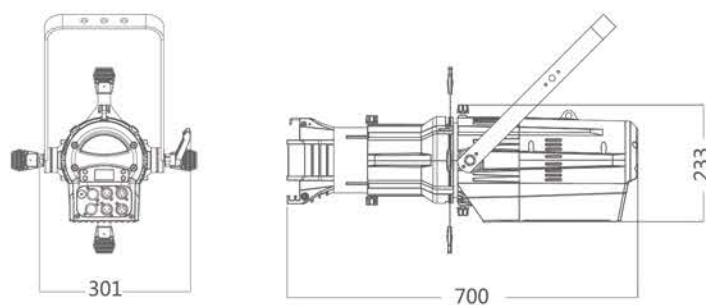

## ACCESSORIES

Accessories not included unless otherwise stated

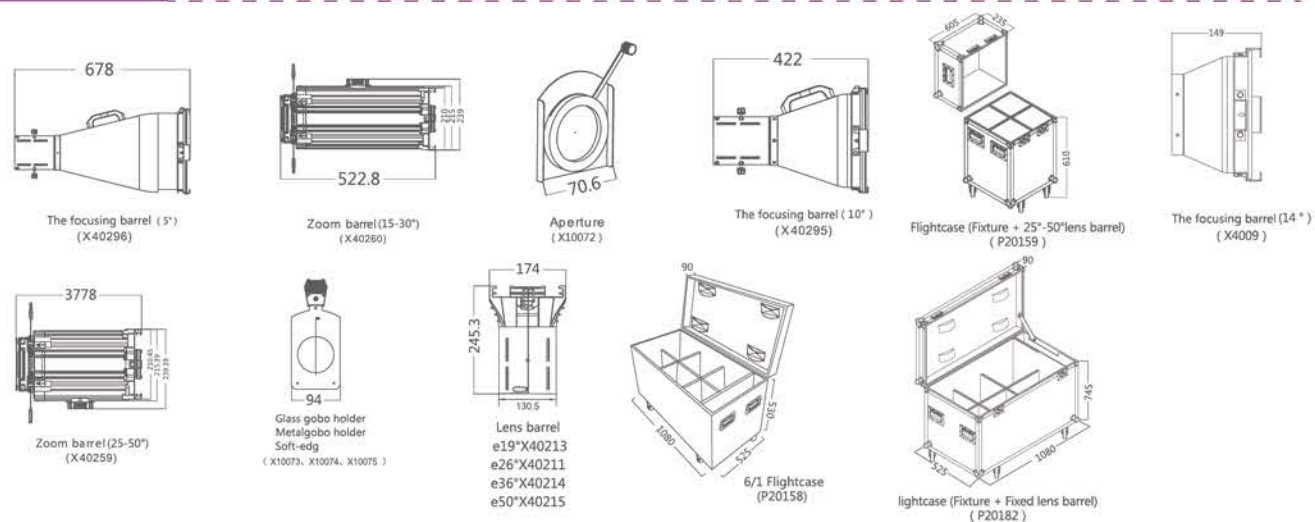

## ILLUMINANCE AT DISTANNXE

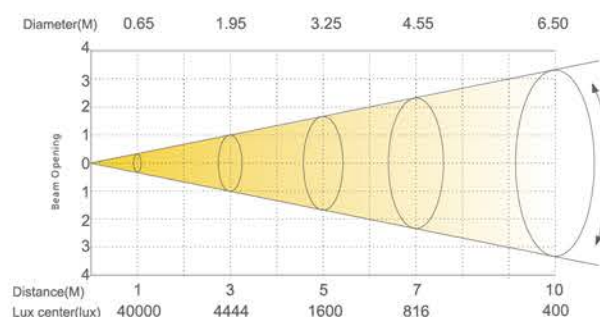
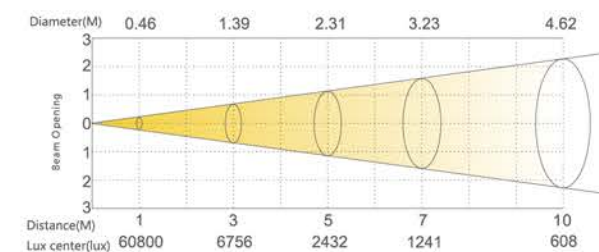
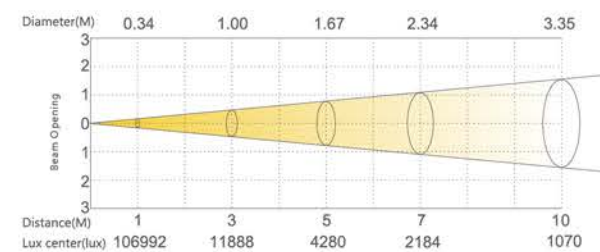
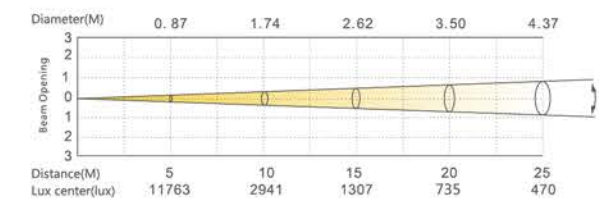
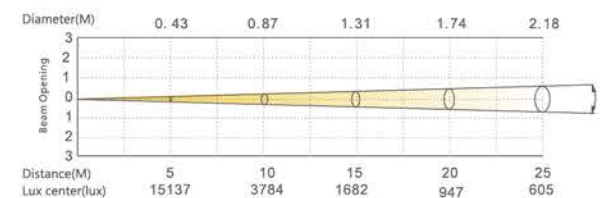



## ECLIPSE 750 IP SS857SWT/SCT

ECLIPSE 750 IP is an innovative IP65 waterproof profile lighting, and it's with High quality optical system can easy choose 3200K or 5600K color temperature. And it's CRI $\geq$ 90Ra, ECLIPSE 750 IP with 15°-30° Electronic zoom system and cutting system can be controlled smooth and accurate. It's design for the cultural tourism market, theme park, outdoor live-action performance, Rental performance market.



To get more infos

### Optical system

- Light source : 250W
- CCT : 3200K, 5600K
- CRI :  $\geq$ 90Ra
- CQS :  $>$ 90
- Angle : 15°-30°

### Electrical Specs

- Voltage : 100-240VAC,50/60Hz
- Max. powe : 240W
- Drive Current : 3.7A
- Power Connection : Power in
- DMX XLR : DMX in/out

### Control System

- Dimmer : 0-100%16Bit
- Cooling : Forced Convection
- Control : DMX512, RDM
- Display : On board Control, 0-25Hz Strobe
- Con Personality : SIMPLE(5CHS) , MODE 16BIT(8CHS)

### Appearance

- Size : 812x343x286mm
- Weight : 16kg
- Casing : Die-cast aluminum
- Color : Black

### Work Environment

- Ambient Temp : -20°C-45°C
- IP Rated : IP65

### Certification

- CE, MET

## DIMENSIONS

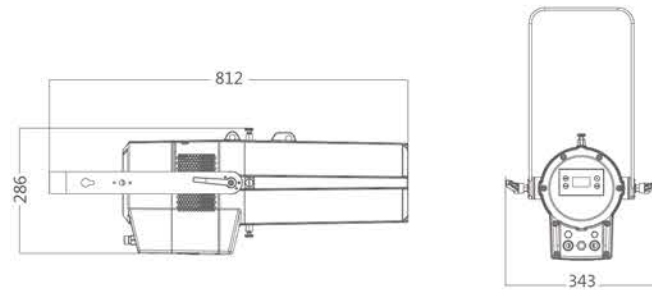

## ACCESSORIES

Accessories not included unless otherwise stated

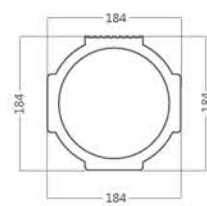

Accessory holder  
( X40432 )

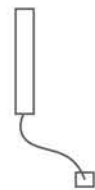

Wireless module, W-DMX Set  
( X10172 )

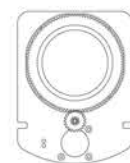

Rotating Gobo set  
( 1340500994 )

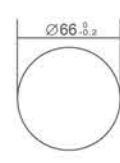

Gobo Image Size

## ILLUMINANCE AT DISTANNXE

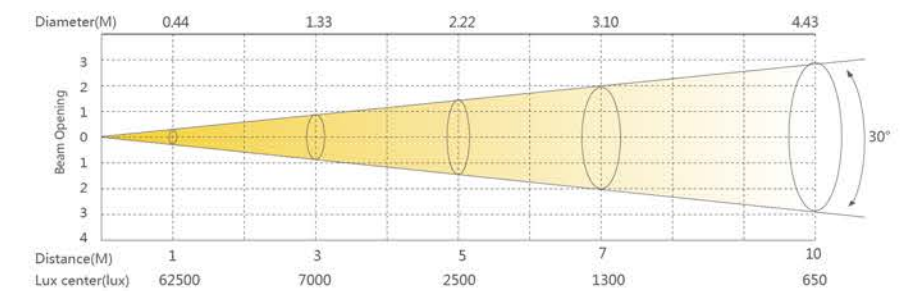
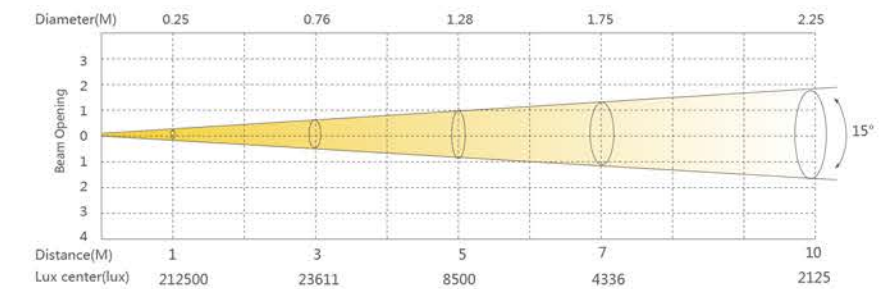



## ECLIPSE COLOR IP SS857XCET/XALT

ECLIPSE COLOR IP is an innovative IP65 waterproof multi-color profile lighting, and it's with High quality optical system can easy change color temperature from 2700K to 8000K. ECLIPSE COLOR IP with 15°-30° Electronic zoom system and cutting system can be controlled smooth and accurate. It has rotation gobo wheel can project rich LOGO. ECLIPSE COLOR IP is design for the cultural tourism market, theme park, outdoor live-action performance, Rental performance market.

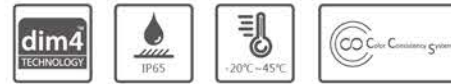

To get more infos

### Optical system

#### SS857XCET

- Light source : 250W ( RGBW )
- CCT : 2700K-8000K
- Angle : 15°-30°

#### SS857XALT

- 250W (RGBAL)
- 2700K-8000K
- 15°-30°

### Appearance

- Size : 812x343x286mm
- Weight : 16kg
- Casing : Die-cast aluminum
- Color : Black

### Electrical Spec

- Voltage : 100-240VAC,50/60Hz
- Max. power : 250W
- Drive Current : 1.2A
- Power Connection : Power in
- DMX XLR : DMX in/out

- 100-240VAC,50/60Hz
- 240W
- 1.6A
- Power in
- DMX in/out

### Work Environment

- Ambient Temp : -20°C-45°C
- IP Rated : IP65

### Control System

- Dimmer : 0-100%16Bit
- Cooling : Forced Convection
- Control : DMX512, RDM
- Display : On board Control,0-25Hz Strobe
- Con Personality : HSIC(8CHS), SIMPLE(9CHS), COLOR MODE 8BIT(12CHS), COLOR MODE 16BIT(17 CHS)

- 0-100% 16Bit
- Forced Convection
- DMX512, RDM
- On board Control,0-25Hz Strobe
- HSIC(8CHS), SIMPLE(10CHS), COLOR MODE 8BIT(13CHS), COLOR MODE 16BIT(19CHS)

### Certification

- CE, MET

### DIMENSIONS ECLIPSE COLOR IP

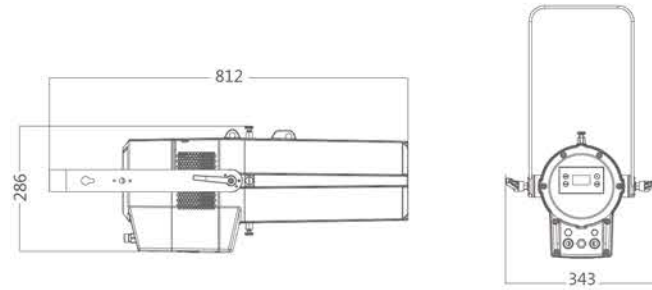

### ACCESSORIES Accessories not included unless otherwise stated

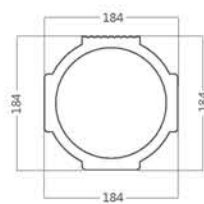

Accessory holder ( X40432 )

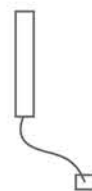

Wireless module, W-DMX Set ( X10172 )



Rotating Gobo set ( 1340500994 )

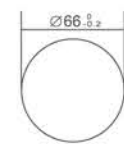

Gobo Image Size

### ILLUMINANCE AT DISTANCE

#### SS857XCET

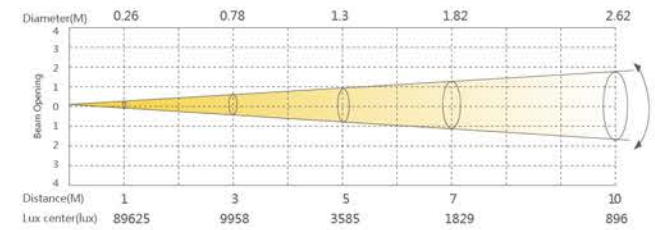

#### SS857XALT

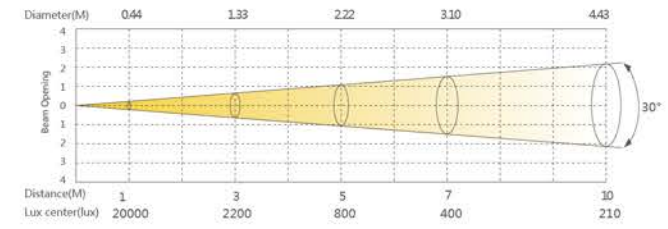
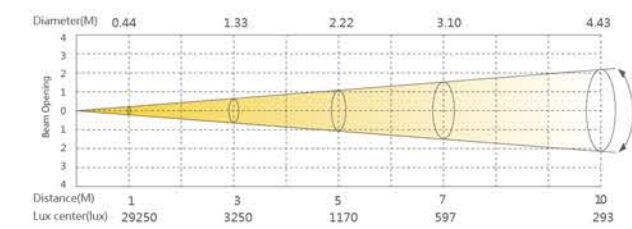
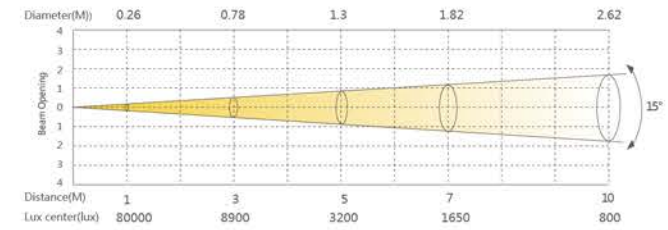



### FREZNO MINI SS868SW/SC

The FREZNO MINI with super stylish design, extremely lightweight and compact, warm white 3200K and cool white 5600K optional, manual dimmer on board, manual zoom 12°-34°. Fanless design and quite performance, DMX512 and RDM protocol, perfect tool for museum, TV station, exhibition, gallery, hotel, and retail shops ect.



### FREZNO MINI D SS868SWD/SCD

The FREZNO MINI D with super stylish design, extremely lightweight and compact, warm white 3200K and cool white 5600K optional, manual zoom 12°-34°. Fanless design and quite performance, fully compatible with TRI-AC control, smooth dimming curve, it is a truly perfect tool for theatre, museum, gallery, hotel, and retail shops ect.



#### DIMENSIONS

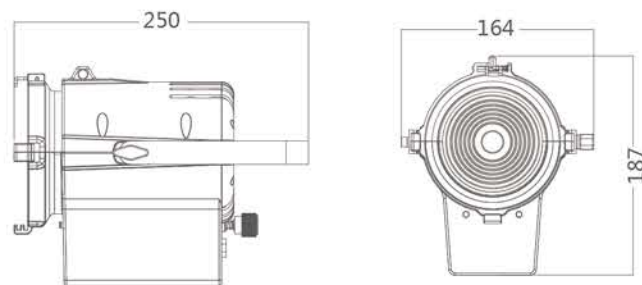

#### ACCESSORIES

Accessories not included unless otherwise stated

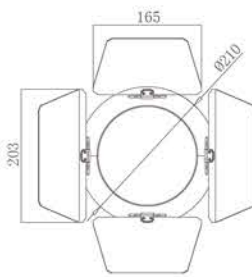

Barn doors  
(X40482)

#### Optical system

##### SS868SW/SC

- Light source : 40W LED
- Angle : 12°-34°
- CCT : 3200K, 5600K

##### SS868SW D/SC D

- 40W LED
- 12°-34°
- 3200K, 5600K

#### Electrical Specs

- Voltage : 100-240VAC , 50/60Hz
- Max. power : 22W
- Drive Current : 0.55A
- Power Connection : Power in
- DMX XLR : 3pin in and out

- 100-120 VAC /220-240VAC,50/60Hz
- 27W
- 0.63A
- Power in
- 3pin in and out

#### Control System

- Dimmer : 0-100%16Bit
- Cooling : Direct Convection
- Control : DMX512, RDM
- Con Personality : DIMMER(1CHS)

- 0-100%16Bit
- Direct Convection
- Dimming Pack Control

#### Appearance

- Size : 250x164x187mm
- Weight : 2.4kg
- Casing : Die-cast aluminum
- Color : Black

#### Work Environment

- Ambient Temp : 0°C-45°C
- IP Rated : IP20

#### Certification

- CE, MET

#### ILLUMINANCE AT DISTANNXE

##### SS868SW

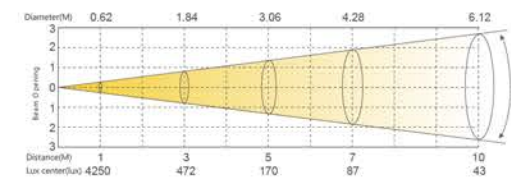
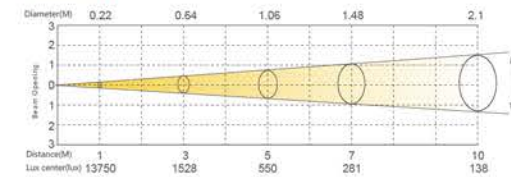

##### SS868SC

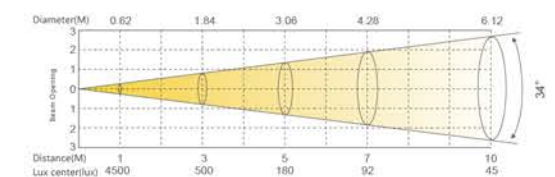
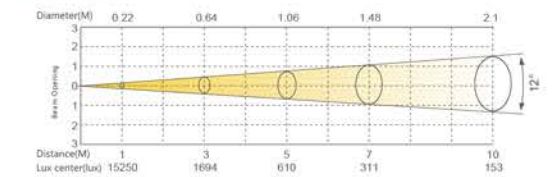

##### SS868SWD

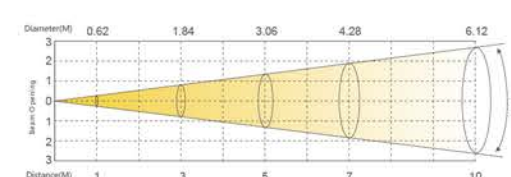
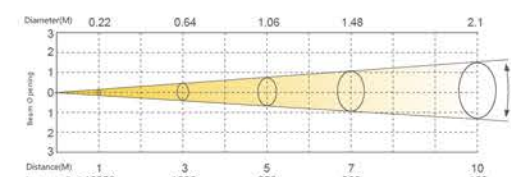

##### SS868SCD

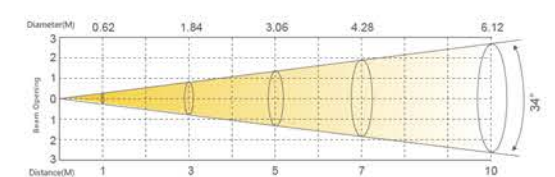
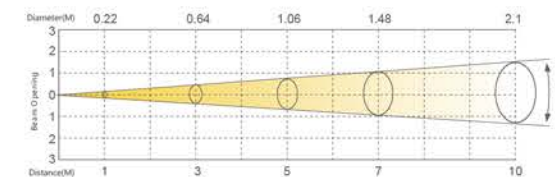



## mobi FREZNO MINI SS869SW/SC

The mobi FREZNO MINI is a super compact and portable BATTERY Fresnel, with high efficient LED, lithium battery, long duration time last for 6-20hrs, manual zoom 12°-34°, manual dimmer on board, fanless design and quite performance, ideal tool for touring show, gallery, banquet and temporary exhibition, photography ect.



To get more infos

### Optical system

- Light source : 40W LED
- Angle : 12°-34°
- CCT : 3200K、 5600K

### Electrical Specs

- Voltage : 100-240VAC, 50/60Hz
- Max. power : 20W
- Drive Current : 0.55A
- Power Connection : Power in

### Control System

- Dimmer : manual dimmer
- Cooling : Direct Convection

### Battery Info

- Charging Cycle : 2.3h
- Pwer Cable : 2600mA
- Run time : 6-20h (Subject to output level)

### Appearance

- Size : 250x164x187mm
- Weight : 2.5kg
- Casing : Die-cast aluminum
- Color : Black

### Work Environment

- Ambient Temp : 0°C-45°C
- IP Rated : IP20

### Certification

- CE、 MET

## DIMENSIONS

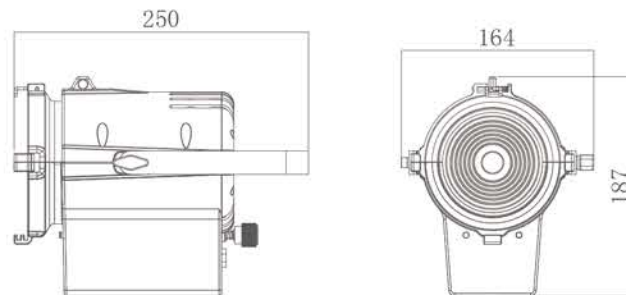

## ACCESSORIES

Accessories not included unless otherwise stated

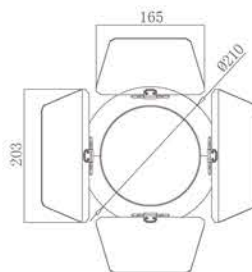

Barn doors  
(X40482)

## ILLUMINANCE AT DISTANNXE

### SS869SW

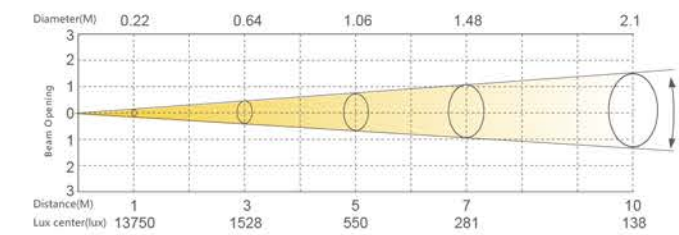

### SS869SC

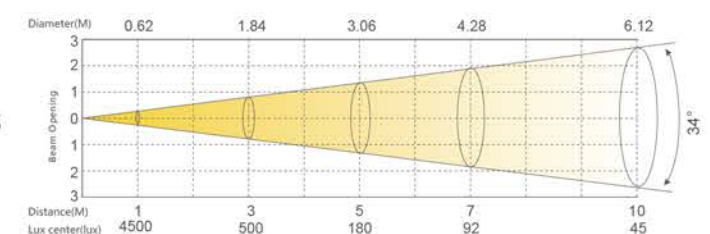
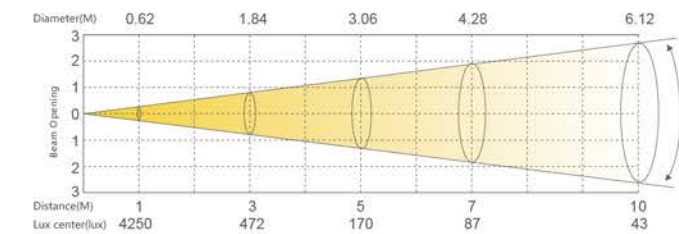
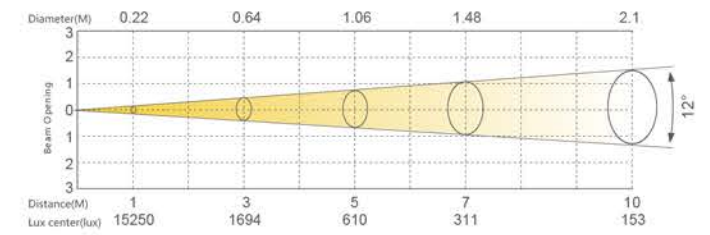



## FREZNO zm-1 HD SS810SW HD/ SC HD

This product is design for theater, television station, and studio. And the illumination is 50% higher than the First-generation product. High CRI and high illumination are true for our brand concept. With 10°-60° Electronic zoom system can be controlled smooth and accurate.



To get more infos

## FREZNO zm-1 HDD SS810SW HDD/ SC HDD

This product specifically design for replacing the traditional lamp Fresnel, which controlled by the dimmer pack; It fully match with previous SCR (Silicon Controlled Rectifier)controller, and the DMX512 signal, dimming smooth, no shading. Intelligent power management system can auto-magically recognize the DMX 512 protocol and SCR. High efficient electronic zoom system. 50% brighter over the 1stsuccessful version, CRI> 90, with compact structure, professional industrial design, zm-1HDDHD is a truly energy saving fixture.



To get more infos



### DIMENSIONS

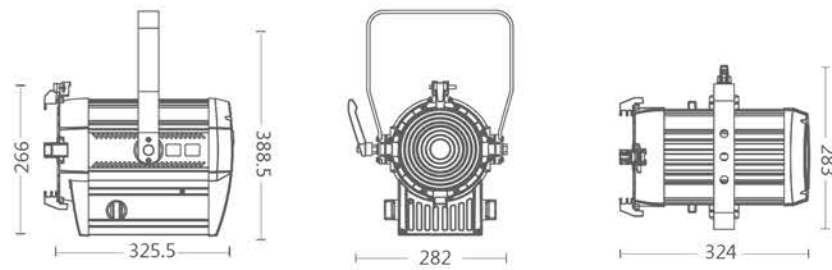

### ACCESSORIES

Accessories not included unless otherwise stated

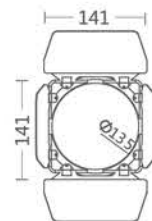

Barn doors  
(X40236)

### Optical system

- Light source : 90W LED
- CCT : 3200K, 5600K
- CRI : ≥90Ra
- CQS : >90
- Angle : 10°-60° ( Manual control )

### Electrical Specs

- Voltage : 100-240VAC,50/60Hz
- Max. power : 105W
- Drive Current : 3A
- Power Connection : Power in/out
- DMX XLR : DMX in/out

### Control System

- Dimmer : 0-100%16Bit
- Cooling : Forced Convection
- Control : DMX512, [Dimming Pack Control, RDM(SS810SW HDD/ SC HDD)]
- Display : On board Control, 0-25Hz Strobe
- Con Personality : UNO(1CH) , DOS(2CHS) , STD.P(3CHS)
- Zoom : Manual

### Appearance

- Size : 324x282x266mm
- Weight : 6.1kg
- Casing : Extruded aluminum
- Color : Black

### Work Environment

- Ambient Temp : 0°C-45°C
- IP Rated : IP20

### Certification

- CE, MET

### ILLUMINANCE AT DISTANNXE

SS810SW HD/SW HDD

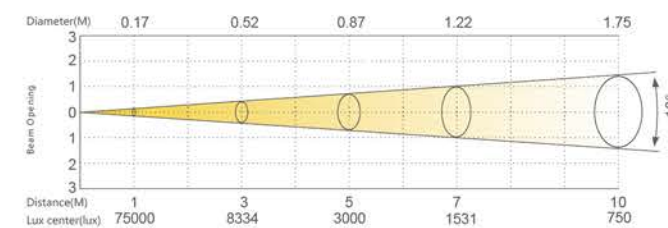

SS810SC HD/SC HDD

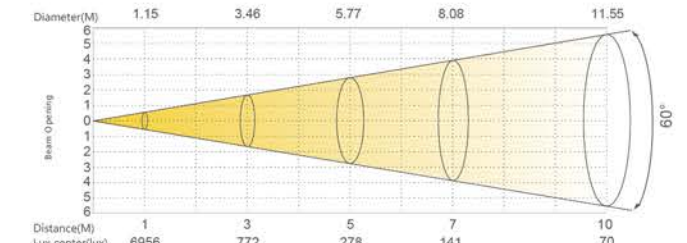
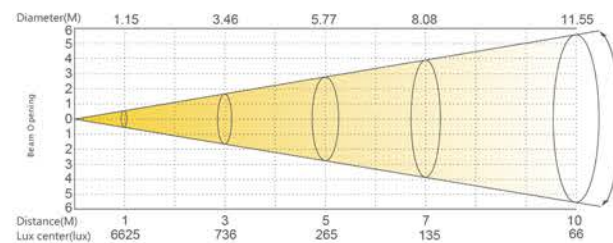
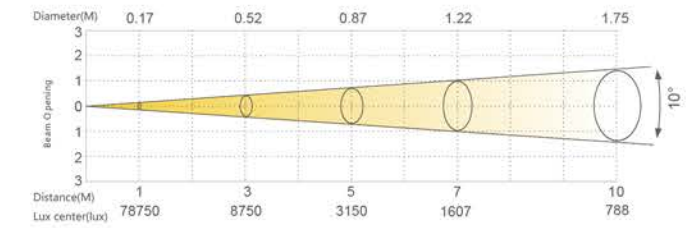



## FREZNO Ze-2 HD SS808SW HD /SC HD

The FREZNO Ze-2 HD is a professional Fresnel with high density integrated source, 50% higher output over the 1st great successful version, can truly replace the traditional 2000W Fresnel. Equipped with smooth and precise electronic zoom system, CRI>90, it is professional intelligent lighting designed for theater, TV studio, banquet, and all kinds of conference hall etc.



To get more infos

## FREZNO ze-D2 HD SS808SW HDD/ SC HDD

This product specifically design for replacing the traditional lamp Fresnel, which controlled by the dimmer pack; It fully match with previous SCR (Silicon Controlled Rectifier) controller, and the DMX512 signal, dimming smooth, no shading. Intelligent power management system can automatically recognize the DMX 512 protocol and SCR. High efficient electronic zoom system. 50% brighter over the 1st successful version, CRI> 90, with compact structure, professional industrial design, FREZNO ze-D2 HD is a truly energy saving fixture.



To get more infos

### DIMENSIONS

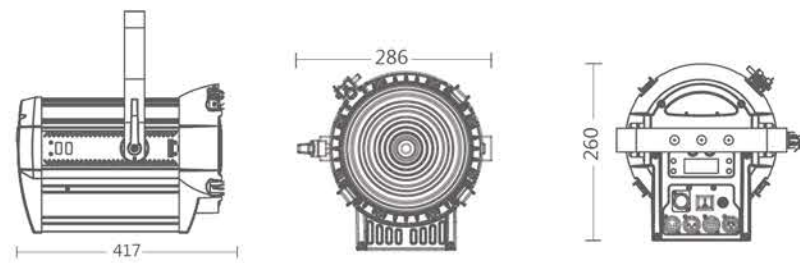

### ACCESSORIES

Accessories not included unless otherwise stated

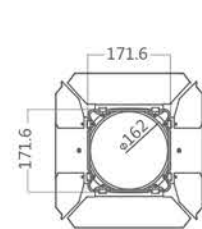

Barn doors  
(X40225)

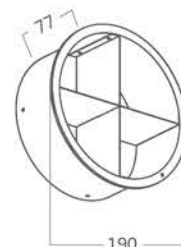

Short hat  
(X40115)

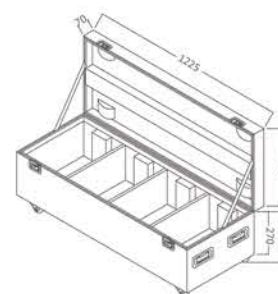

Flight Case  
(P20100)

### Optical system

- Light source : 250W
- CCT : 3200K, 5600K
- CRI : ≥90Ra
- CQS : >90
- Angle : 15°-60°

### Electrical Specs

- Voltage : 100-240VAC,50/60Hz
- Max. power : 250W
- Drive Current : 3A
- Power Connection : Power in/out
- DMX XLR : DMX in/out

### Control System

- Dimmer : 0-100%16Bit
- Cooling : Forced Convection
- Control : DMX512. [RDM, Dimming Pack Control(SS808SW HDD/ SC HDD)]
- Display : On board Control, 0-25Hz Strobe
- Zoom : Manual Control
- Con Personality: UNO/1CHS, DOS/2CHS, STD.P/5CHS

### Appearance

- Size : 417x286x260mm
- Weight : 6.6kg
- Casing : Extruded aluminum
- Color : Black

### Work Environment

- Ambient Temp : 0°C-45°C
- IP Rated : IP20

### Certification

- CE, MET

### ILLUMINANCE AT DISTANNXE

#### SS808SW HD/SW HDD

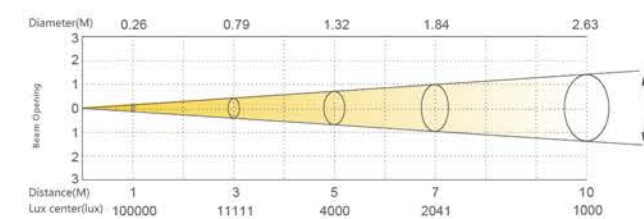

#### SS808SC HD/SC HDD

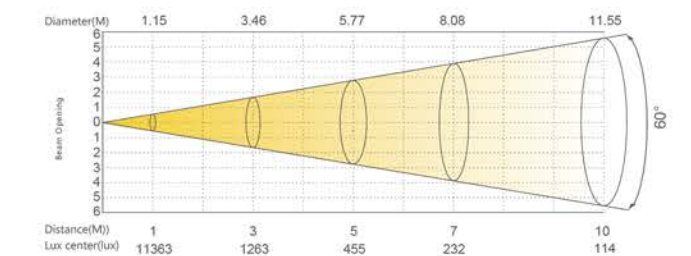
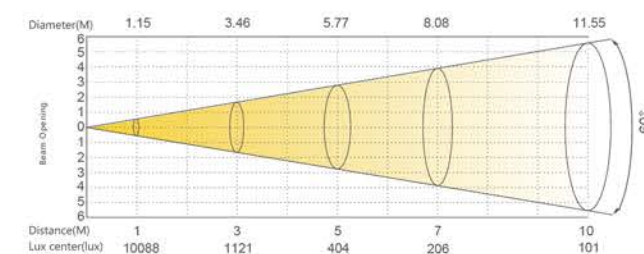
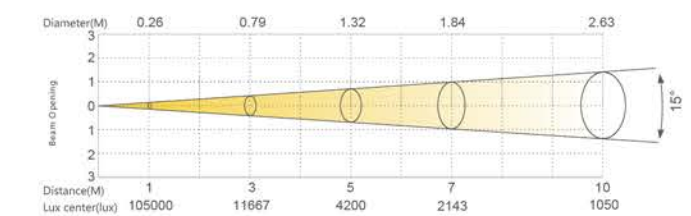



## FREZNO ze-3 HD SS811SW HD/SC HD

This fixture is specialized designed for Theater, TV, and Studio. High powerful light, High CRI, Continuation of energy conservation and environmental protection. High efficient brand idea. Electronic zoom 15°-60°, 16bit dimmer smooth, no shake.



To get more infos

### Optical system

- Light source : 300W LED
- CCT : 3200K, 5600K
- CRI : ≥90Ra
- CQS : >90
- Angle : 15°-60°

### Electrical Specs

- Voltage : 100-240VAC,50/60Hz
- Max. power : 300W
- Drive Current : 3A
- Power Connection : Power in/out
- DMX XLR : DMX in/out

### Control System

- Dimmer : 0-100%16Bit
- Cooling : Forced Convection
- Control : DMX512
- Display : On board Control, 0-25Hz Strobe
- Con Personality : UNO(1CH) , DOS(2CHS) , STD.P(5CHS)

### Appearance

- Size : 485x333x322mm
- Weight : 7.8kg
- Casing : Extruded aluminum
- Color : Black

### Work Environment

- Ambient Temp : 0°C-45°C
- IP Rated : IP20

### Certification

- CE, MET

## DIMENSIONS

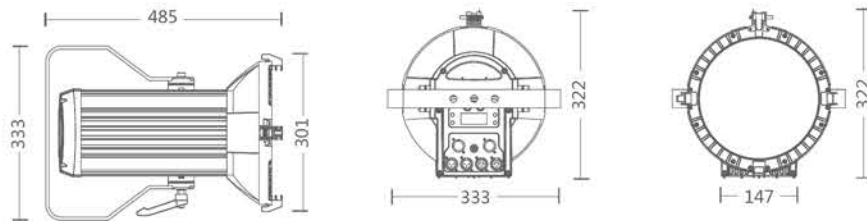

## ACCESSORIES

Accessories not included unless otherwise stated

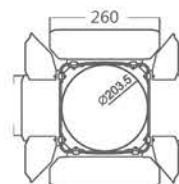

Barn doors  
(X40252)

## ILLUMINANCE AT DISTANCE

### SS811SW HD

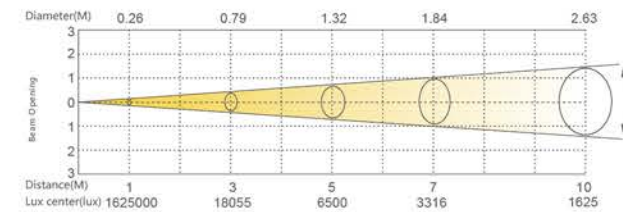

### SS811SC HD

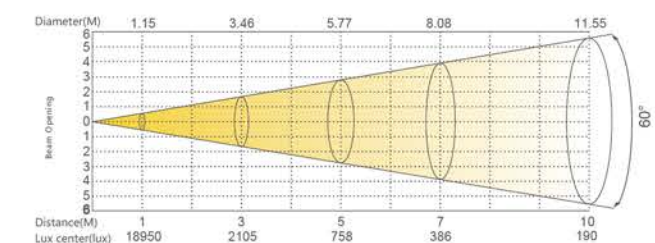
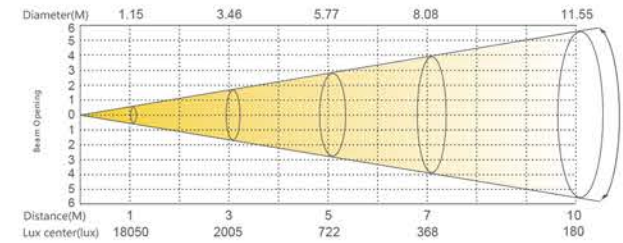
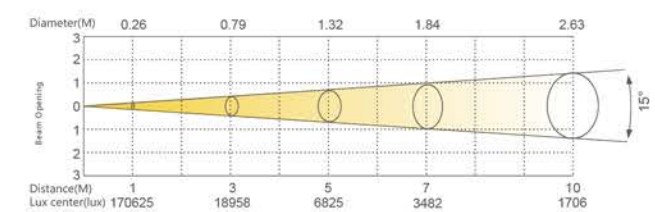



## FREZNO ze-2 RGBAL SS815XAL

As an innovative 5 color Fresnel, FREZNO ze-2RGBAL is applied with high-effective optics system, thus generating in excellent color-mixing performance. With HSIC intelligent system, you can mix any color you wanted easily. Color temperatures from 2700K to 8000K, 16 kinds of professional color are programmed. It is an ideal product for professional lighting in TV station, studio, exhibition, conference hall, theater etc.



To get more infos

### Optical system

- Light source : 200W LED RGBAL
- CCT : 2700K-8000K
- CRI :  $\geq 90Ra$
- CQS :  $> 90$
- Angle : 15°-45°

### Electrical Specs

- Voltage : 100-240VAC,50/60Hz
- Max. power : 240W
- Drive Current : 1.5A
- Power Connection : Power in/out
- DMX XLR : DMX in/out

### Control System

- Dimmer : 0-100%16Bit
- Cooling : Forced Convection
- Control : DMX512, RDM
- Display : On board Control, 0-25Hz Strobe
- Con Personality : HSIC(8CHS) , SSP(10CHS) , TOUR(13CHS) , TR16(19CHS)

### Appearance

- Size : 510x285x261mm
- Weight : 7.6kg
- Casing : Extruded aluminum
- Color : Black

### Work Environment

- Ambient Temp : 0°C-45°C
- IP Rated : IP20

### Certification

- CE, MET

## DIMENSIONS

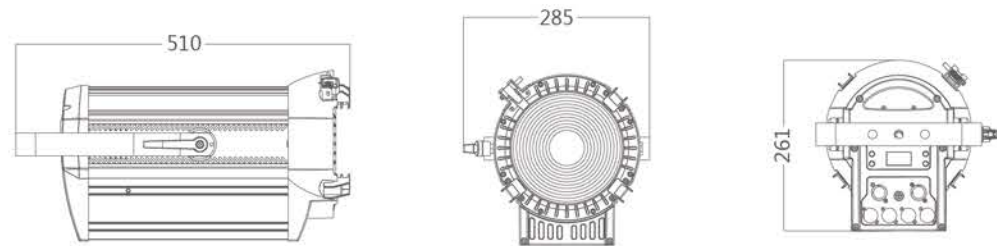

## ACCESSORIES

Accessories not included unless otherwise stated

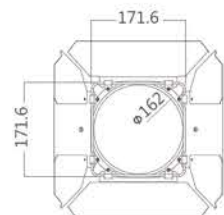

Barn doors (X40225)

## ILLUMINANCE AT DISTANCE

### 3200K

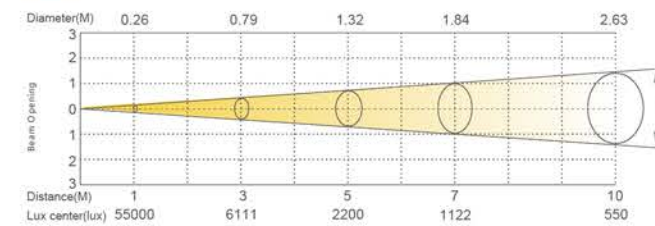

### 5600K

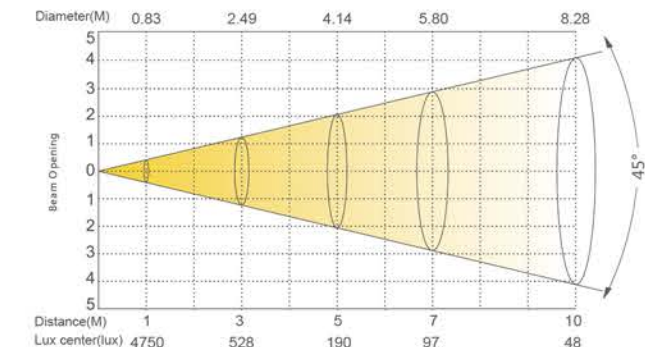
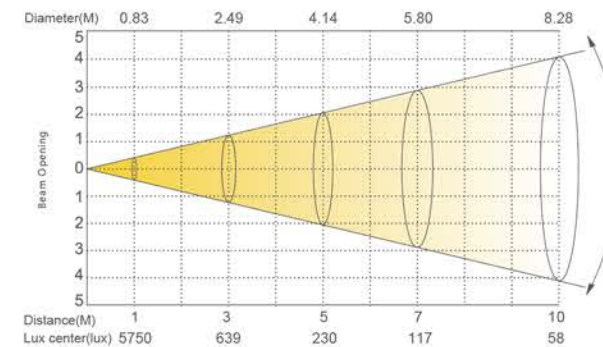
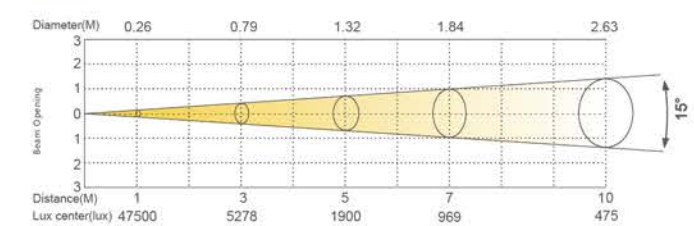



## MYCYC2 SS822XAL

MYCYC2 applying the new RGBAL optics technology, unique asymmetrical optics, it is at least 20% brighter than first generation MYCYC. With advanced HSIC color mixing system, can easily pick up whatever colors you need. Also it can quickly recall the most common used CCT from 2700k-8000k. The MYCYC2 is fully replacing the traditional cyclorama.



To get more infos

### Optical system

- Light source : 20xRed, 20xGreen, 20xBlue, 8xLime, 12xAmber
- CCT : 2700K-8000K
- CRI :  $\geq 90Ra$
- CQS :  $> 90$
- Angle :  $45^\circ \times 60^\circ$

### Electrical Specs

- Voltage : 100-240VAC, 50/60Hz
- Max. power : 150W
- Drive Current : 700mA
- Power Connection : Power in/out
- DMX XLR : DMX in/out

### Control System

- Dimmer : 0-100% 16Bit
- Cooling : Direct Convection
- Control : DMX512 , RDM
- Display : On board Control, 0-25Hz Strobe, Custom Mode
- Con Personality : HSIC(7CHS) , SSP(9CHS) , TOUR(12CHS) , TR16(18CHS) , PIXEL.1(9CHS) , PIXEL.2(13CHS)

### Appearance

- Size : 390x310x298mm
- Weight : 10kg
- Casing : Extruded aluminum
- Color : Black

### Work Environment

- Ambient Temp :  $0^\circ\text{C} - 45^\circ\text{C}$
- IP Rated : IP20

### Certification

- CE, MET

## DIMENSIONS

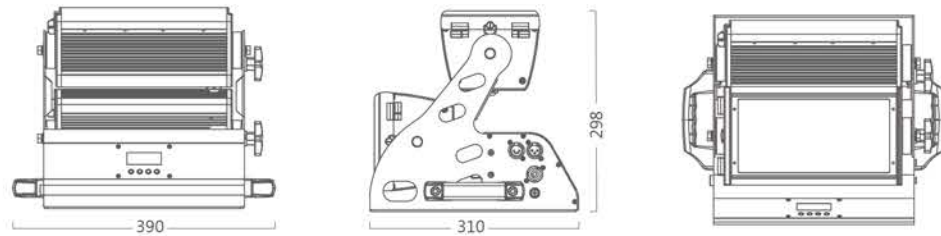

## ACCESSORIES

Accessories not included unless otherwise stated

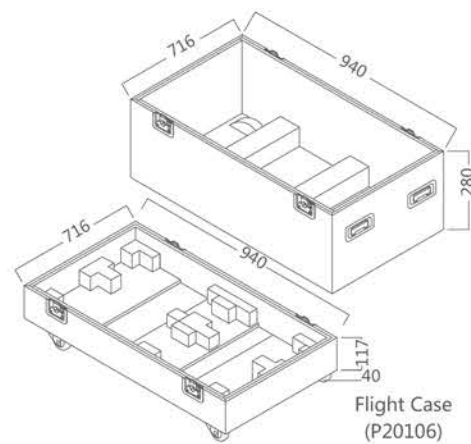

Flight Case  
(P20106)

## ILLUMINANCE AT DISTANCE

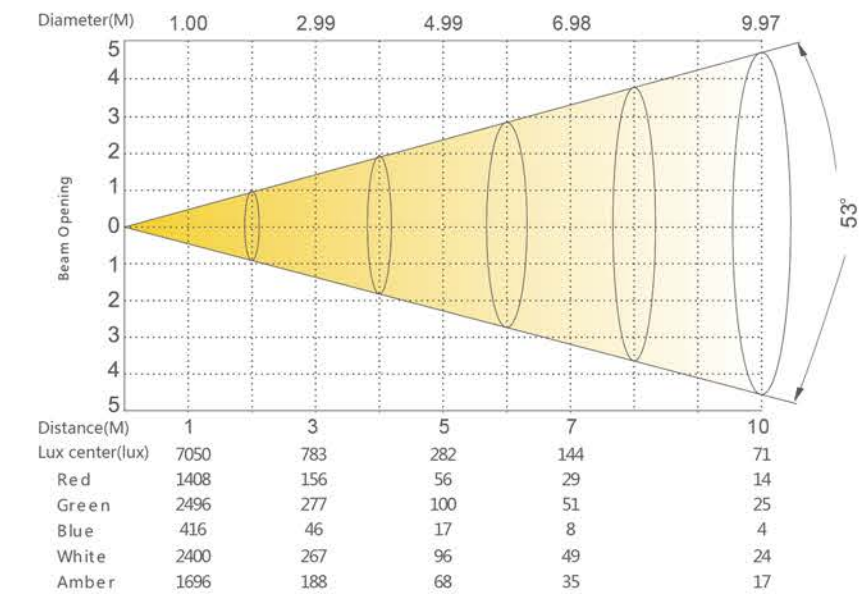



### MAXCYC SS809XCA

The MAXCYC is powerful led with cyclorama, new innovational HISC system, extremely smooth color mixing, can replace the real 1250W traditional cyclorama, idea for theatre.



To get more infos

#### Optical system

- Light source : 32xRed, 32xGreen, 32xBlue, 16xWhite, 16xAmber
- CCT : 3200K-10000K
- CRI : ≥90Ra
- CQS : >90
- Angle : 45°x60°

#### Electrical Specs

- Voltage : 100-240VAC,50/60Hz
- Max. power : 310W
- Drive Current : 700mA
- Power Connection : Power in/out
- DMX XLR : DMX in/out

#### Control System

- Dimmer : 0-100%16Bit
- Cooling : Direct Convection
- Control : DMX512
- Display : On board Control,0-25Hz Strobe, Custom Mode
- Con Personality : HSIC(7CHS) , ARC.1(3CHS) , AR1.D(4CHS) , ARC2(4CHS) , AR3(5CHS) , AR3D(6CHS) , AR3.S(7CHS), TOUR(11CHS) , TR16(17CHS) , PIXEL.1(6CHS),PIXEL.3(10CHS) , PIXEL.16(22CHS)

#### Appearance

- Size : 622x310x327mm
- Weight : 15kg
- Casing : Extruded aluminum
- Color : Black

#### Work Environment

- Ambient Temp : 0°C-45°C
- IP Rated : IP20

#### Certification

- CE, MET

#### DIMENSIONS

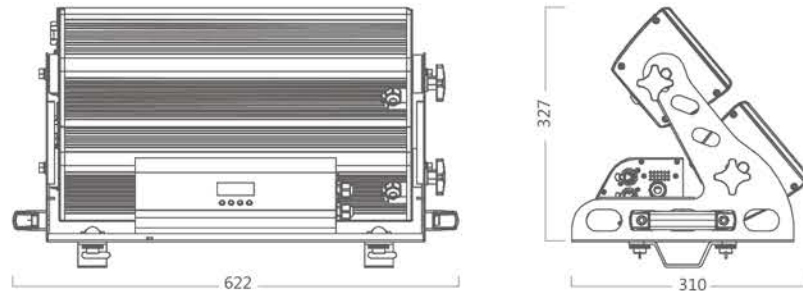

#### ACCESSORIES

Accessories not included unless otherwise stated

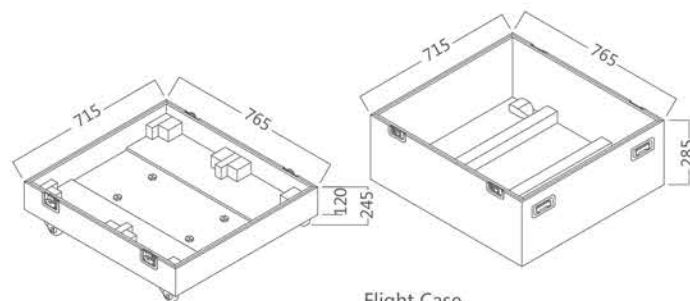

Flight Case  
(P20110)

#### ILLUMINANCE AT DISTANCE

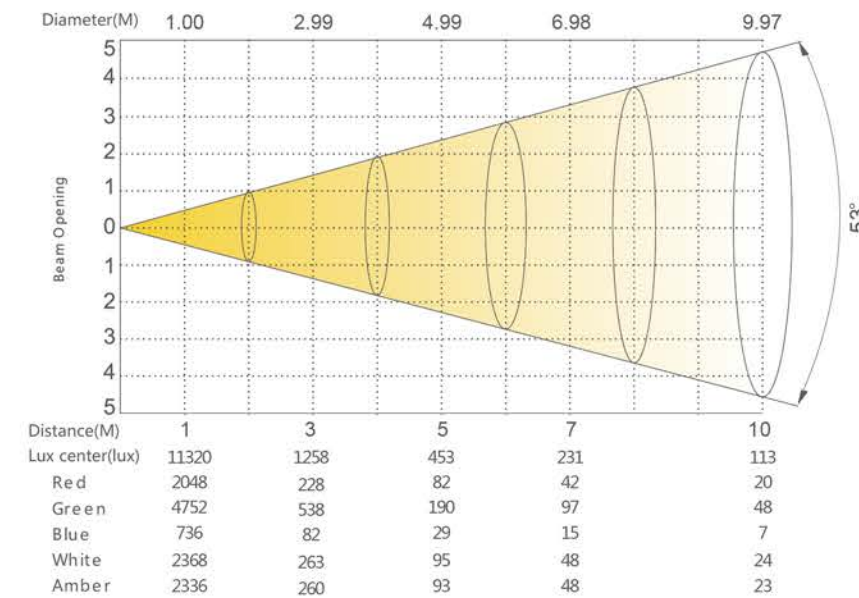



## ULTIcyc SS819XS

The 1st professional LED cyclorama apply with 7 special selected- colors, truly- presents the full color spectrum. Using the asymmetric optics and advanced HSIC color management system, mixing colors in an ultra-fast and easy way. You can select high quality white colors from 2700k- 8000k, with high CRI >90; Perfect for all kinds of large and medium theatre, studio, also the rental events.



To get more infos

### Optical system

- Light source : 48xRed, 32xGreen, 24xBlue, 16xDeep Blue, 16xCyan, 40xLime, 24xAmber
- CCT : 2700K-8000K
- CRI :  $\geq 90Ra$
- CQS : >90
- Angle : 50°x60°

### Electrical Specs

- Voltage : 100-240VAC,50/60Hz
- Max. power : 340W
- Drive Current : 700mA
- Power Connection : Power in/out
- DMX XLR : DMX in/out

### Control System

- Dimmer : 0-100%16Bit
- Cooling : Direct Convection
- Control : DMX512 , RDM
- Display : On board Control,0-25Hz Strobe, Custom Mode
- Con Personality : HSIC(7CHS) , SSP(11CHS) , TOUR(14CHS) , TR16(22CHS) ,PIXEL.1(9CHS) , PIXEL.2(17CHS)

### Appearance

- Size : 622x310x327mm
- Weight : 15kg
- Casing : Extruded aluminum
- Color : Black

### Work Environment

- Ambient Temp : 0°C-45°C
- IP Rated : IP20

### Certification

- CE, MET

## DIMENSIONS

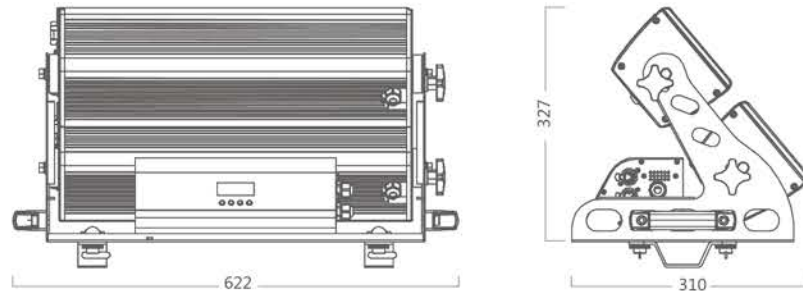

## ACCESSORIES

Accessories not included unless otherwise stated

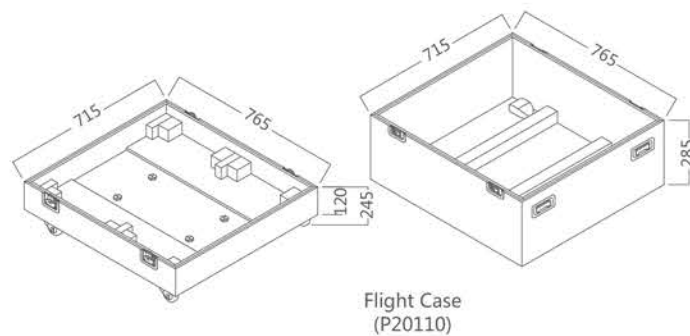

Flight Case  
(P20110)

## ILLUMINANCE AT DISTANNXE

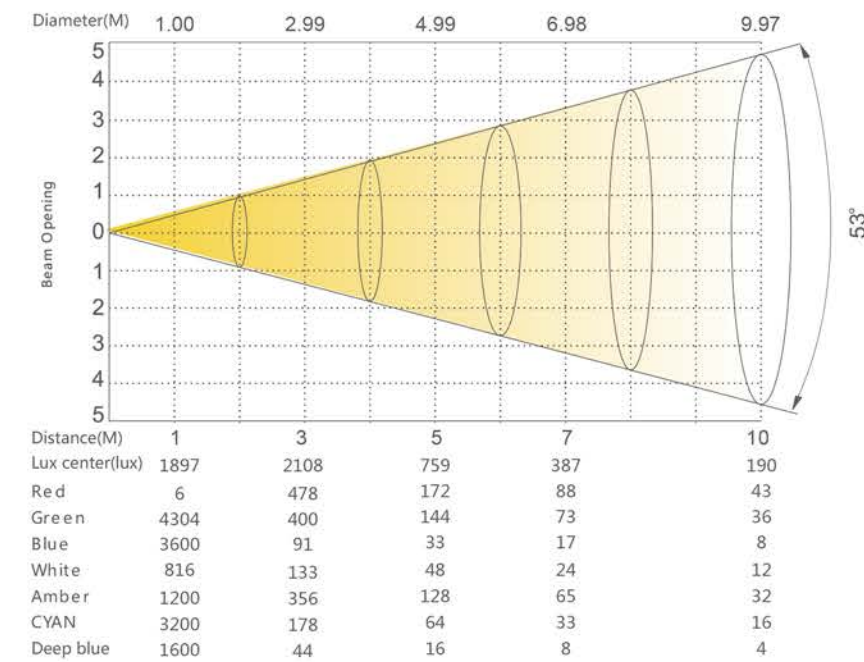



## TRACER SS824SC

TRACER is a new type pure manual control follow spot, with 250W customized high-efficient LED module, delicate design fully consider of the human operate habits; Super flexible control including the dimmer, iris, zoom, focus, color change; Precise zoom range 10-20 projection stay sharp and clear on any angles; Smart structure design separate the heat-sink an optic system, easy and convenient for clean and maintenance. The TRACER is born for the small-medium size theatre, auditorium, church, banquet hall. Rental house application.



To get more infos

### Optical system

- Light source : 250W LED
- CCT : 5600K
- CRI :  $\geq 90Ra$
- CQS :  $> 90$
- Angle : 10°-20° ( Manual Zoom )

### Electrical Specs

- Voltage : 100-240VAC,50/60Hz
- Max. power : 230W
- Drive Current : 3.5A
- Power Connection : Power in

### Control System

- Dimmer : 0-100%16Bit
- Cooling : Forced Convection
- Control : Dimmer, Iris, Zoom, Focus, Boomerang

### Appearance

- Size : 1136x353x436mm
- Weight : 23kg
- Casing : Metal
- Color : Black

### Work Environment

- Ambient Temp : 0°C-45°C
- IP Rated : IP20

### Certification

- CE, MET

## DIMENSIONS

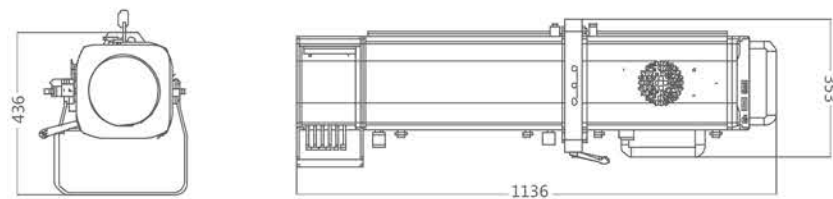

## ACCESSORIES

Accessories not included unless otherwise stated

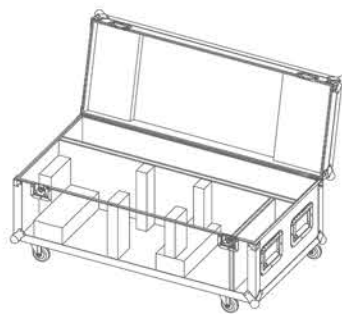

Flight case (P20178)



Follow light tripod (X40363)

## ILLUMINANCE AT DISTANCE

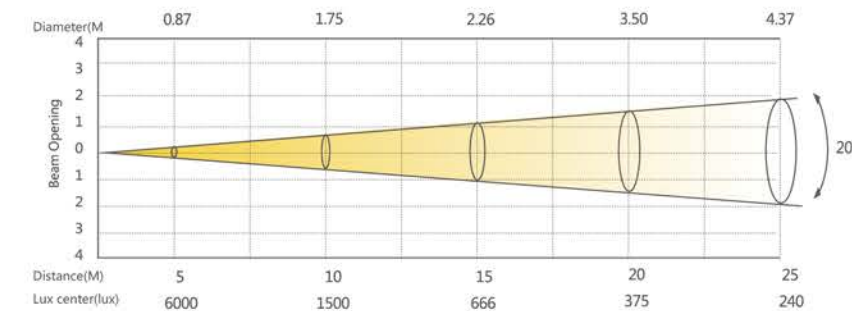
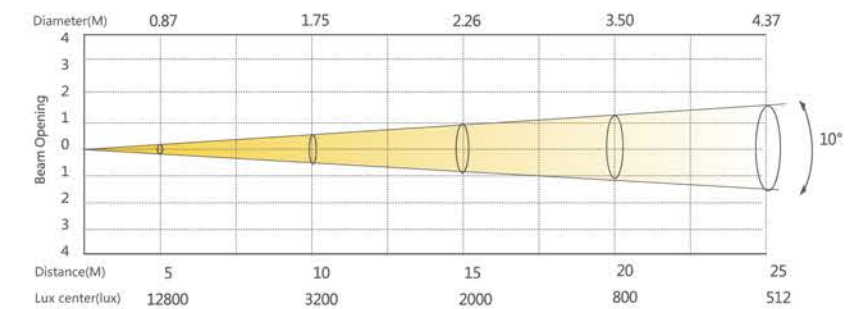



The TOURZ series of products are quickly becoming the industry standard across various markets around the world. The TOURZ range not only provides powerful, clean, consistent LED lighting for a wide range of applications but also sets a new standard with regards to quality and ruggedness. TOURZ lighting fixtures offer impressive performance and are dedicated to suiting the lighting designers needs.

# Neo CYC IP SS361XALM

Neo CYC IP is a brand new bar wash lighting with IP65. Break through the traditional Border Light idea. It can be easier to control its colors. Neo CYC IP has outstanding RGBAL mixing optical effects that enables an endless layout of patterns and graphic display. It's color temperature can be easy controlled from 1800K to 8000K, and It's CRI is higher than 90 Ra. Neo CYC IP has 25° optical and can be easy to change angle. With HSIC Intelligent mixing color system can be easy mixing any color. Neo CYC IP can also be controlled each single LED independently, and with RDM and ARTNET control protocol. It's design for the cultural tourism market, theme park, outdoor live-action performance, Rental performance market.



To get more infos



## DIMENSIONS

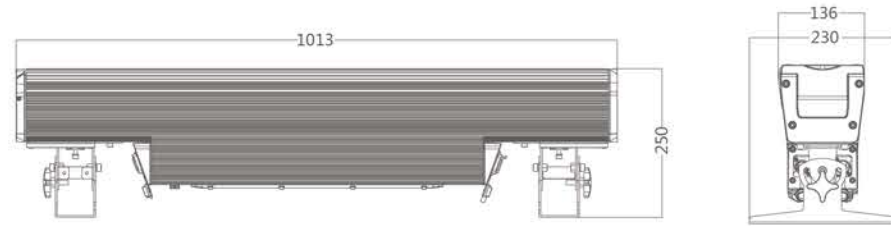

## ACCESSORIES

Accessories not included unless otherwise stated

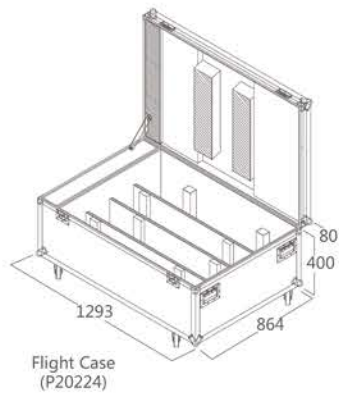

Flight Case (P20224)

- |                              |                              |
|------------------------------|------------------------------|
|                              | Frost filter 20° (X40379)    |
| Frost filter 30° (X40415)    | Frost filter 40° (X40416)    |
| Frost filter 55° (X40417)    | Frost filter 40*10° (X40418) |
| Frost filter 60*10° (X40419) | Frost filter 60*1° (X40469)  |

## Optical system

- Light source : 12x30W (RGBAL)
- Angle : 25°(40° , 40°x20° , 60°x20°optional)
- CCT : 1800-8000K
- CRI : ≥90Ra
- CQS : > 90

## Electrical Specs

- Voltage : 100-240VAC,50/60Hz
- Max. Power : 320W
- Drive Current : 600mA
- Power Connection : Power in/out,
- DMX xlr : 3/5XLR-DMX in/out, RJ45 in/out

## Control System

- Dimmer : 0-100% 16Bit
- Cooling : Direct Convection
- Control : DMX512, RDM, ARTNET, SACN
- Display : On board Control , Custom Mode , 0-25Hz Strobe
- Con Personality : HSIC/7CHS ,SSP/8CHS ,TOUR/12CHS , TR16/18CHS,PIXEL.1/39CHS , PIXEL.2/63CHS

## Appearance

- Size : 1013x230x255mm
- Weight : 18kg
- Casing : Extruded aluminum, Die-cast aluminum
- Color : Black

## Work Environment

- Ambient Temp : -20°C-45°C
- IP Rated : IP65

## Certification

- CE, MET

## ILLUMINANCE AT DISTANNXE

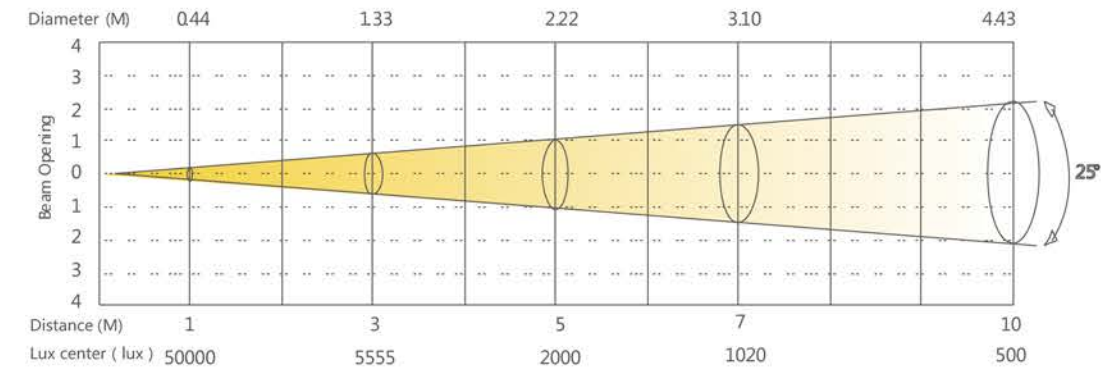

## MINI CYC IP SS364XALM

MINI CYC IP is a brand new bar wash lighting with IP65. Break through the traditional Border Light idea. It can be easier to control its colors. MINI CYC IP has outstanding RGBAL mixing optical effects that enables an endless layout of patterns and graphic display. it's color temperature can be easy controlled from 1800K to 8000K, and It's CRI is higher than 90 Ra. MINI CYC IP has 25° optical and can be easy to change angle. With HSIC Intelligent mixing color system can be easy mixing any color. MINI CYC IP can also be controlled each single LED independently, and with RDM and ARTNET control protocol. It's design for the cultural tourism market, theme park, outdoor live-action performance, Rental performance market.



To get more infos

### DIMENSIONS

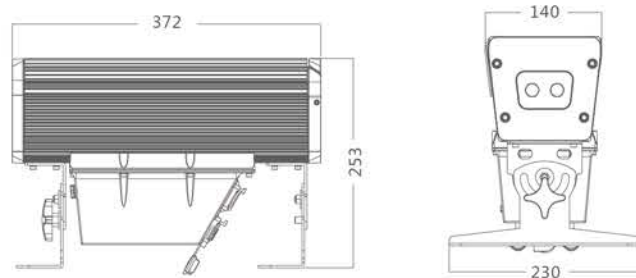

### ACCESSORIES

Accessories not included unless otherwise stated

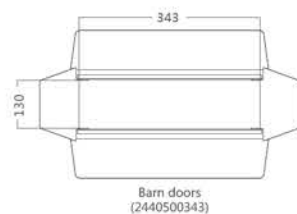

Barn doors  
(2440500343)

- |                              |                                  |
|------------------------------|----------------------------------|
| Frost filter 30°<br>(X40420) | Frost filter 40°*10°<br>(X40423) |
| Frost filter 40°<br>(X40421) | Frost filter 60°*10°<br>(X40424) |
| Frost filter 55°<br>(X40422) | Frost filter 60°*1°<br>(X40467)  |

### Optical system

- Light source : 4x30W (RGBAL)
- Angle : 25°(40° , 40°x20° , 60°x20°optional)
- CCT : 1800K-8000K
- CRI : ≥90Ra
- CQS : > 90

### Electrical Specs

- Voltage : 100-240VAC,50/60Hz
- Max. Power : 110W
- Drive Current : 700mA
- Power Connection : Power in/out
- DMX xlr : DMX in/out , RJ45 Power in/out

### Control System

- Dimmer : 0-100% 16Bit
- Cooling : Direct Convection
- Control : DMX512, RDM, ARTNET, sACN
- Display : On board Control , Custom Mode , 0-25Hz Strobe
- Con Personality : HSIC/7CHS ,SSP/8CHS ,TOUR/12CHS ,TR16/18CHS, PIXEL.1/15CHS , PIXEL.2/23CHS, PIXEL.3/20CHS

### Appearance

- Size : 372x230x253mm
- Weight : 7.8kg
- Casing : Extruded aluminum, Die-cast aluminum
- Color : Black

### Work Environment

- Ambient Temp : -0°C-45°C
- IP Rated : IP65

### Certification

- CE, MET

### ILLUMINANCE AT DISTANNXE

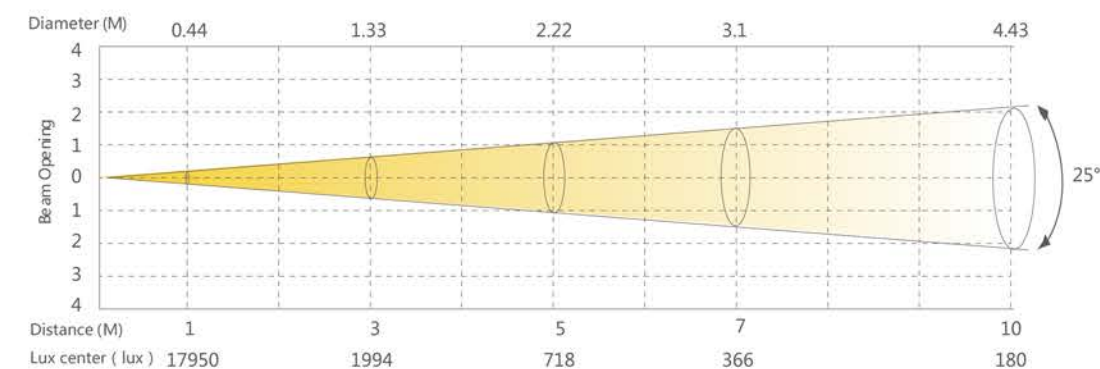

## NeoCYC SS356XAL

The NeoCYC infuse the innovative concept to the traditional Border Light or LED Batten / Bar. With special customized 5 color optics, 12 x 30W powerful modules, it brings endless color possibilities, and extremely even color mixing. Precise preset CCT from 1800-8000K at  $\geq 90Ra$ ; Applying HSIC color system, individual 12 pixel control, support RDM / ARTNET protocol, terrific silent design, it is a perfect fixture for theatre, TV station, or any professional rental application.



To get more infos



### DIMENSIONS

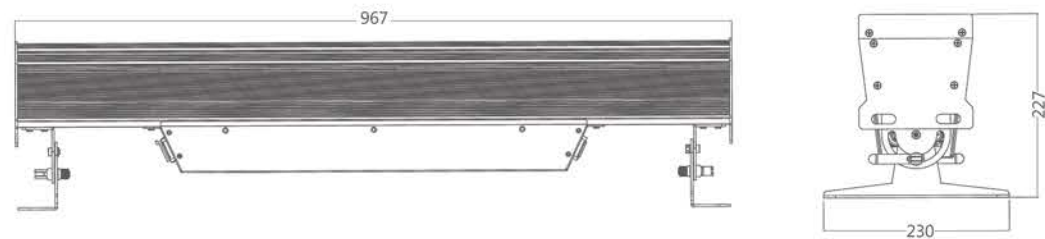

### ACCESSORIES

Accessories not included unless otherwise stated

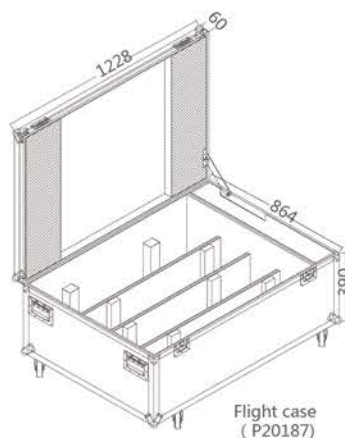

Flight case  
( P20187)

Frost filter 60°\*10°  
( X40350)

Frost filter 40°\*10°  
( X40351)

Frost filter 30°  
( 2220000167)

Frost filter 40°  
( 2220000168)

lithium battery  
( 1160000482)

### Optical system

- Light source : 12x30W (RGBAL)
- Angle : 25°(40° , 40°x20° , 60°x20°optional)
- CCT : 1800-8000K
- CRI :  $\geq 90Ra$
- CQS :  $> 90$

### Electrical Specs

- Voltage : 100-240VAC,50/60Hz
- Max. Power : 320W
- Drive Current : 600mA
- Power Connection : Power in/out
- DMX xlr : DMX in/out , RJ45 Power in/out

### Control System

- Dimmer : 0-100% 16Bit
- Cooling : Direct Convection
- Control : DMX512, RDM, ARTNET, SACN
- Display : On board Control , Custom Mode , 0-25Hz Strobe
- Con Personality : HSIC/7CHS ,SSP/8CHS ,TOUR/12CHS ,  
TR16/18CHS,PIXEL.1/39CHS , PIXEL.2/63CHS

### Appearance

- Size : 967x230x227mm
- Weight : 12.5kg
- Casing : Extruded aluminum
- Color : Black

### Work Environment

- Ambient Temp : 0°C-40°C
- IP Rated : IP20

### Certification

- CE, MET

### ILLUMINANCE AT DISTANNXE

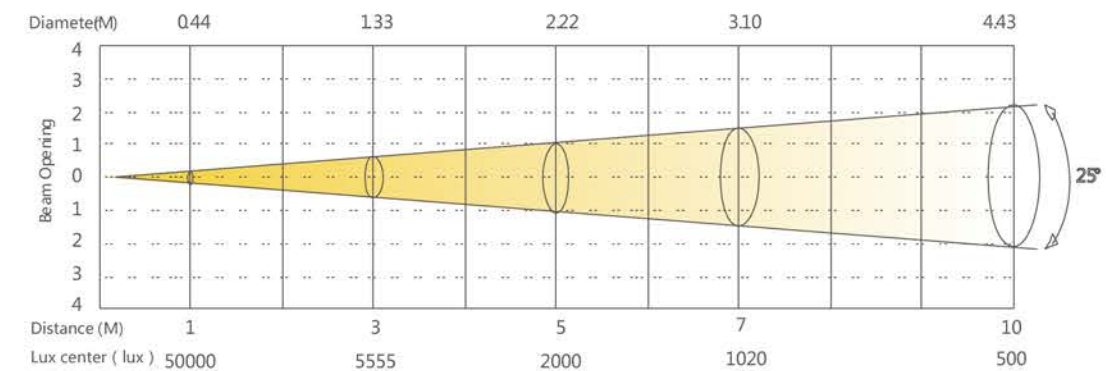



## MINI CYC SS366XAL

MINI CYC infuse the innovative concept to the traditional Border light/Batten/Bar. With special customized 5 colors optics, 4 x 30W powerful modules, it brings endless color possibilities, and extremely even color mixing. Precise preset CCT from 1800-8000K, typical CRI  $\geq 90$ Ra; Applying HSIC color system, individual pixel control, support RMD /ARTNET protocol, noise-free design, it is an dream fixture for Theatre, TV station, Studio and Rental house application.



To get more infos

### Optical system

- Light source : 4x30W (RGBAL)
- Angle : 25°(40° , 40°x20° , 60°x20°optional)
- CCT : 1800-8000K
- CRI :  $\geq 90$ Ra
- CQS :  $> 90$

### Electrical Specs

- Voltage : 100-240VAC,50/60Hz
- Max. Power : 108W
- Drive Current : 600mA
- Power Connection : Power in/out,
- DMX xlr : 3/5XLR-DMX in/out, RJ45 in

### Control System

- Dimmer : 0-100% 16Bit
- Cooling : Direct Convection
- Control : DMX512, RDM, ARTNET, SACN
- Display : On board Control , Custom Mode , 0-25Hz Strobe
- Con Personality : HSIC/7CHS ,SSP/8CHS ,TOUR/12CHS ,TR16/18CHS, PIXEL.1/15CHS , PIXEL.2/23CHS

### Appearance

- Size : 326x230x234mm
- Weight : 5.5kg
- Casing : Extruded aluminum
- Color : Black

### Work Environment

- Ambient Temp : -0°C-45°C
- IP Rated : IP20

### Certification

- CE, MET

## DIMENSIONS

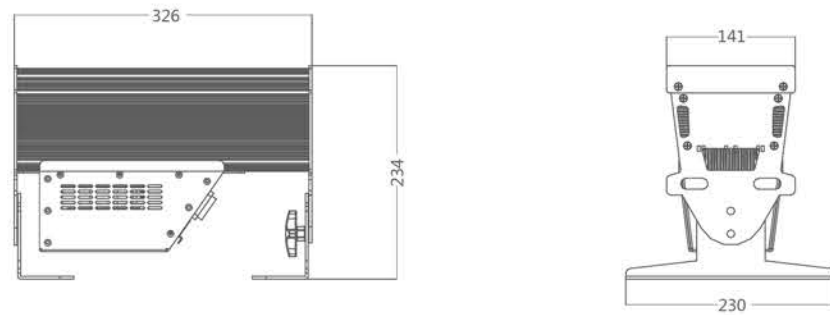

## ACCESSORIES

Accessories not included unless otherwise stated

Frost filter 40°  
(X40439)

Frost filter 40°10°  
(X40440)

Frost filter 60°10°  
(X40441)

## ILLUMINANCE AT DISTANNXE

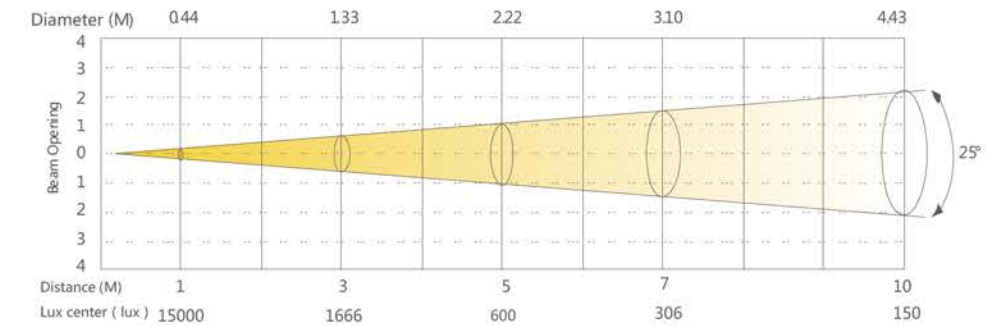



## RAYTHEON SS353XCEM

RAYTHEON is a high power professional LED strobe, the max output up to 1100W, creates astonishing strobe effect. The industrial IP65 design assures the installation much convenient. It has 12 sections control, and compatible with Artnet / RDM. The RAYTHEON is the dream strobe gear for the professional rental / concert / show / events!



To get more infos

### Optical system

- Light source : 144x10W (RGBW)
- Angle : 30°

### Electrical Specs

- Voltage : 100-240VAC,50/60Hz
- Max. Power : 1100W
- Drive Current : 700mA
- Power Connection : Power in
- DMX xlr : DMX in/out, RJ45 Power in

### Control System

- Dimmer : 0-100% 16Bit
- Cooling : Direct Convection
- Control : DMX512, RDM, ARTNET
- Display : On board Control , Custom Mode , 0-25Hz Strobe
- Con Personality : HSIC/9CHS,SSP/8CHS,TR16/17CHS,PIXEL.1/40CHS, PIXEL.2/52CHS,HALOGEN/5CHS

### Appearance

- Size : 585x189x308mm
- Weight : 13.5kg
- Casing : Die-cast aluminum
- Color : Black

### Work Environment

- Ambient Temp : -20°C-45°C
- IP Rated : IP65

### Certification

- CE, MET

## DIMENSIONS

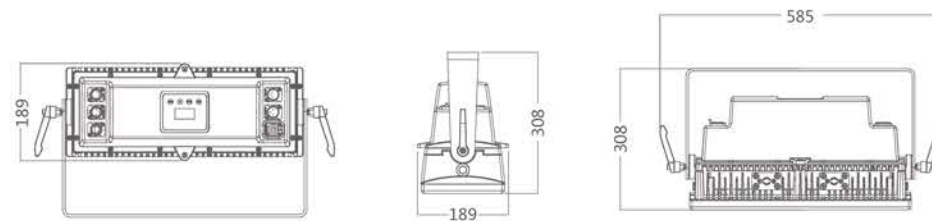

## ACCESSORIES

Accessories not included unless otherwise stated

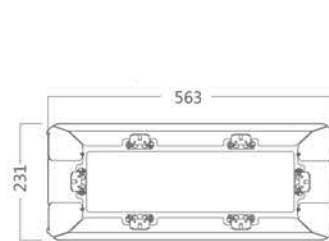

Barn doors  
(X40403)

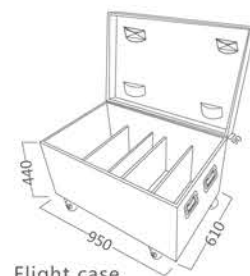

Flight case  
(P20169)

## ILLUMINANCE AT DISTANCE

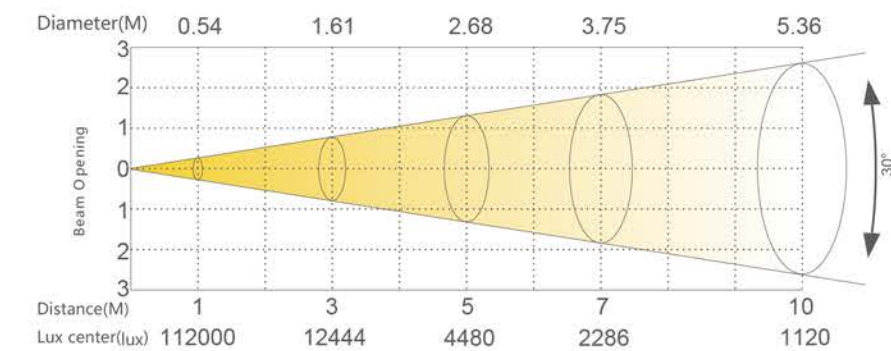



## X3 iZOOM SS350XCEM

X3 iZOOM is a breakthrough-innovative fixture, with independent zoom for 3 LED heads, also individual control of each color. Applied with advanced HSIC color mixing system, can create very even colors. The smooth and precise electronic zoom 4.5-45°, brings a very strong beam effects on small angle, also a perfect wash effect on large angle. IS X3 iZOOM can work as the backlight in the venue, side light, top light etc., which is suitable for all kinds of applications, large and medium-sized concert, rental events etc.



To get more infos

### Optical system

- Light source : 3x60W (RGBW)
- Angle : 4.5-45°

### Electrical Specs

- Voltage : 100-240VAC, 50/60Hz
- Max. Power : 230W
- Drive Current : 4.5A
- Power Connection : Power in/out
- DMX xlr : DMX in/out, RJ45 Power in

### Control System

- Dimmer : 0-100% 16Bit
- Cooling : Direct Convection
- Control : DMX512, RDM, ARTNET
- Display : On board Control , 0-25Hz Strobe , Custom Mode
- Con Personality : HSIC/12CHS , PIXEL.1/17CHS , PIXEL.2/20CHS , TR16/20CHS , HALO/10CHS

### Appearance

- Size : 616x180x262mm
- Weight : 10.5kg
- Casing : Die-cast aluminum
- Color : Black

### Work Environment

- Ambient Temp : -20°C-45°C
- IP Rated : IP65

### Certification

- CE, MET

## DIMENSIONS

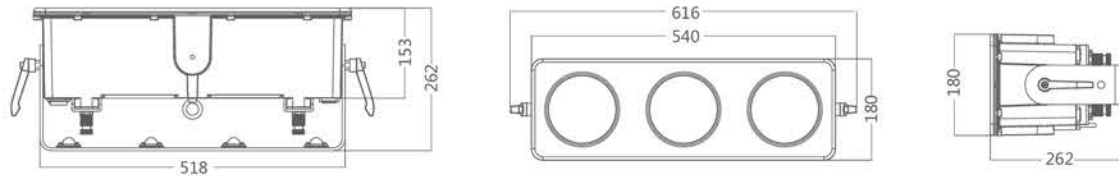

## ACCESSORIES

Accessories not included unless otherwise stated

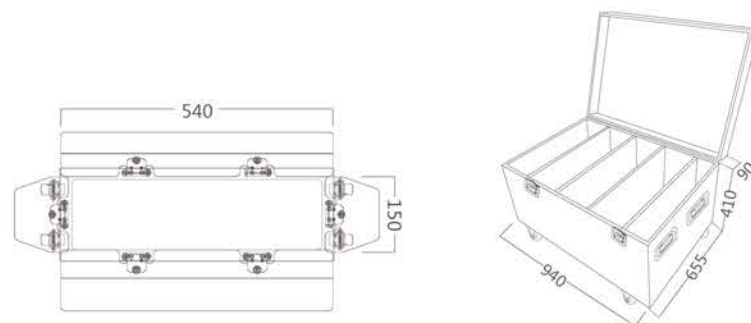

Barn doors  
(X40305)

Flight case  
(P20179)

## ILLUMINANCE AT DISTANCE

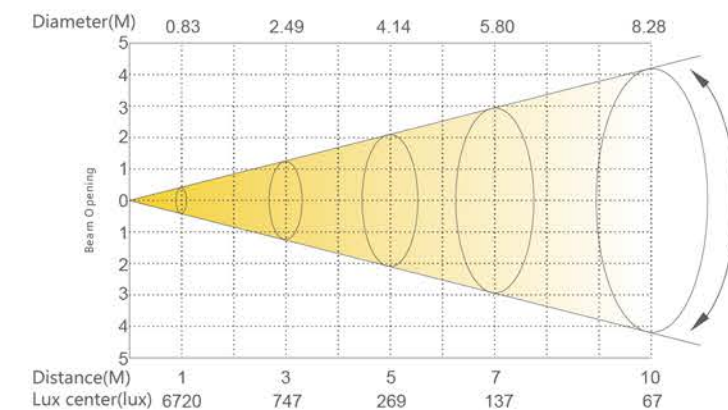
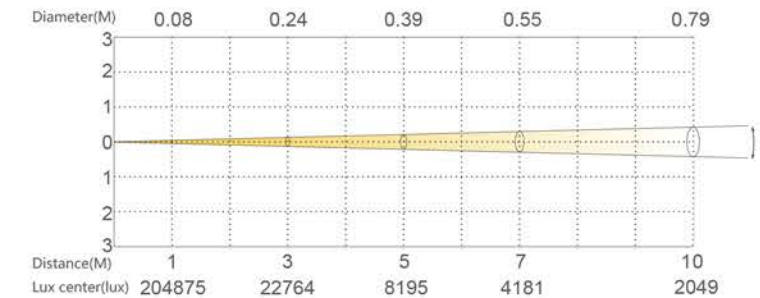

## PixiCYC/ETZ 12 SS359XCET

PixiCYC/ETZ 12 is an upgraded model on the basis of PixiCYC, with 12x10W high efficient RGBW LEDs, it delivers more than 50% output over the last generation, individual pixel control, 2 optics available, 10° for dynamic beam pixel effect, 16° for wide wall wash; Patented DIM4 technology offer the delicate dimming curve to meet all professional needs, IP66. The PixiCYC ETZ 12 is perfect cost-effective item for the Rental house, TV station, Theatre, studio and concert hall applications.



To get more infos



### DIMENSIONS

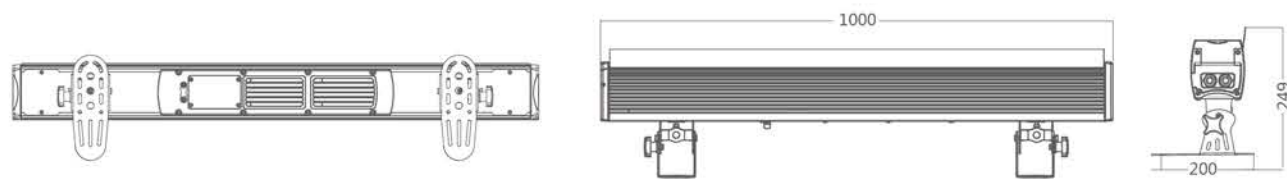

### ACCESSORIES

Accessories not included unless otherwise stated

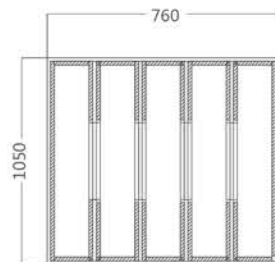
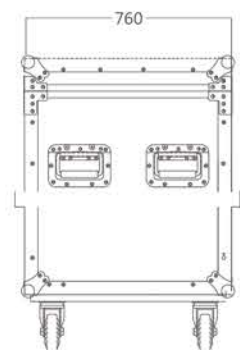

Flight Case  
(P20130)

Frost filter 30°  
(X40472)

### Optical system

- Light source : 12x10W (RGBW)
- Angle : 10° (16° optional)

### Electrical Specs

- Voltage : 100-240VAC, 50/60Hz
- Max. Power : 150W
- Drive Current : 950mA
- Power Connection : Power in/out
- DMX xlr : DMX in/out

### Control System

- Dimmer : 0-100% 16Bit
- Cooling : Direct Convection
- Control : DMX512
- Display : On board Control , 0-20Hz Strobe , Custom Mode
- Con Personality : TOUR/11CHS , TR16/16CHS , ARC2.D/5CHS, ARC2.S/6CHS, HV6/3CHS, ARC1.D/4CHS, ARC2/4CHS, HAL0/12CHS, PIXEL.1/39CHS, PIXEL.2/51CHS, ARC1/3CHS

### Appearance

- Size : 1000x200x249mm
- Weight : 10.5kg
- Casing : Die-cast aluminum
- Color : Black

### Work Environment

- Ambient Temp : -20°C-45°C
- IP Rated : IP66

### Certification

- CE, MET

### ILLUMINANCE AT DISTANNXE

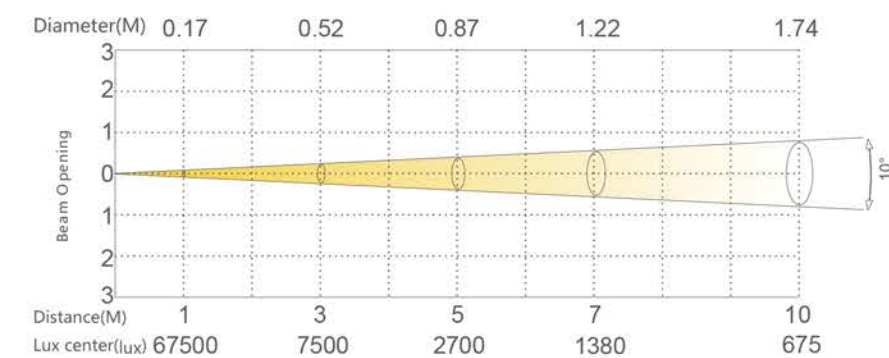

## PixiCYC/EZ 12 SS360XCE

PixiCYC/EZ 12 is an upgraded model on the basis of PixiCYC, with 12x10W high efficient RGBW LEDs, it deliver more than 50% output over the last generation, individual pixel control, 2 optics available, 10° for dynamic beam pixel effect, 16° for wide wall wash; Patented DIM4 technology offer the delicate dimming curve to meet all professional needs. The PixiCYC EZ 12 is perfect cost-effective item for the Rental house, TV station, Theatre, studio and concert hall applications.



### DIMENSIONS

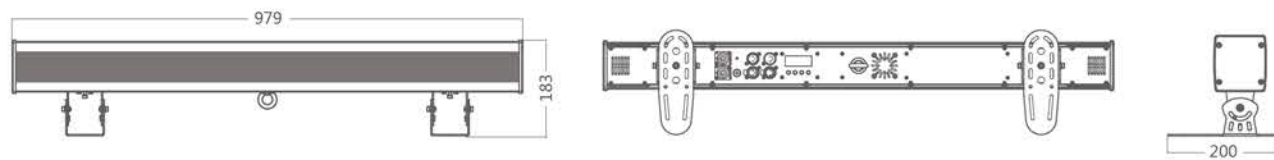

### ACCESSORIES

Accessories not included unless otherwise stated

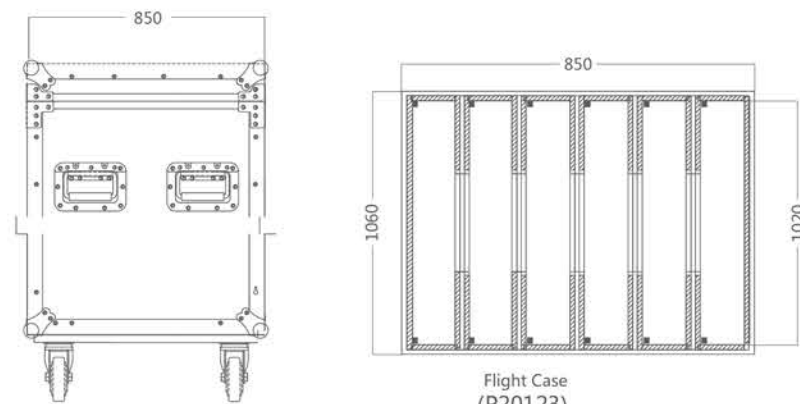

### Optical system

- Light source : 12x10W (RGBW)
- Angle : 10° (16°optional)

### Electrical Specs

- Voltage : 100-240VAC,50/60Hz
- Max. Power : 150W
- Drive Current : 950mA
- Power Connection : Power in/out
- DMX xlr : DMX in/out

### Control System

- Dimmer : 0-100% 16Bit
- Cooling : Direct Convection
- Control : DMX512
- Display : On board Control , 0-25Hz Strobe , Custom Mode
- Con Personality : TOUR/11CHS , TR16/16CHS , AR1.D/4CHS , ARC.2/4CHS , AR2.D/5CHS , HSV/3CHS , HALO/12CHS,ARC2.S/6CHS,PIXEL.1/39CHS, PIXEL.2/51CHS,ARC1/3CHS

### Appearance

- Size : 979x200x183mm
- Weight : 6.5kg
- Casing : Die-cast aluminum
- Color : Black

### Work Environment

- Ambient Temp : -0°C-45°C
- IP Rated : IP20

### Certification

- CE, MET

### ILLUMINANCE AT DISTANNXE

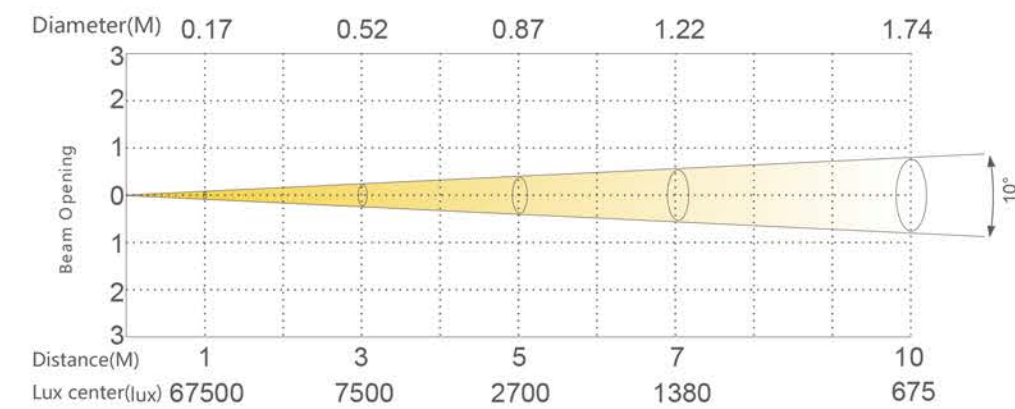



## SUPERNOVA SS352XCEM

The LED PARCAN fashion now back to classic! The SUPERNOVA adopt the high efficient LED module, applying with advanced HSIC color mixing system, intelligent color management. Unique optical design, always one color out of lens, no more color dot! With smart IP65 structure, the SUPERNOVA is ideal for professional rental, TV, studio, theatre, opera, medium to large event application.



## SUPERNOVA/ETZ SS352XCET

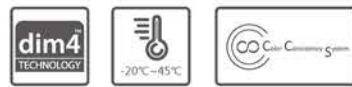

### Optical system

- Light source : 3x60W (RGBW)
- Angle : 4.5°-45°

### Electrical Specs

- Voltage : 100-240VAC, 50/60Hz
- Max. Power : 180W
- Drive Current : 4.5A
- Power Connection : Power in/out
- DMX xlr : DMX in/out

### Control System

- Dimmer : 0-100% 16Bit
- Cooling : Direct Convection
- Control : DMX512, RDM
- Display : On board Control , Custom Mode , 0-25Hz Strobe
- Con Personality : HSIC/9CHS, SSP/9CHS, TOUR/12CHS, TR16/17CHS

### Appearance

- Size : 413x314x250mm
- Weight : 9.1kg
- Casing : Die-cast aluminum
- Color : Black

### Work Environment

- Ambient Temp : -20°C-45°C
- IP Rated :  
SS352XCEM: IP65  
SS352XCET: IP66

### Certification

- CE, MET

## DIMENSIONS

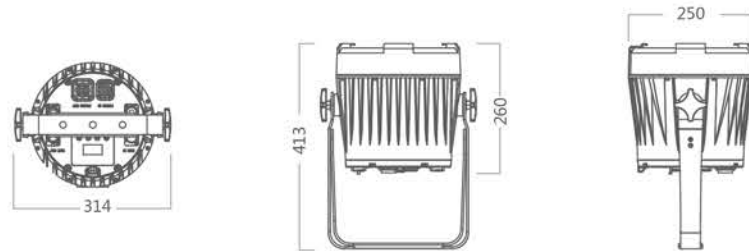

## ACCESSORIES

Accessories not included unless otherwise stated



## ILLUMINANCE AT DISTANCE

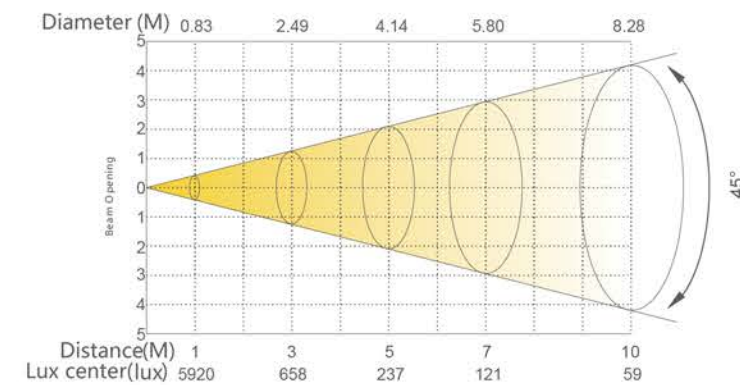
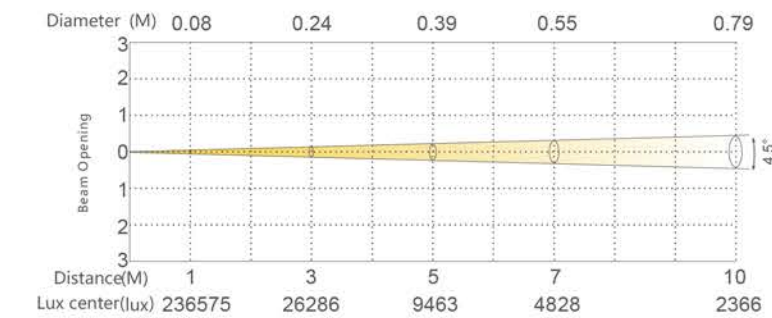



## MYNOVA SS354XCEM

The MYNOVA stands for the new generation LEDPAR, mix the cutting-edge technology and Classic concept; With one big lens, truly homogenized clean lights, no more headache of color dots; The specific precise and smoothzoom system create an incredible range from 4.5-36°; It will not only a tight beam effect tool, but also perfect for large area wash. The MYNOVA is ideal for professional TV, Studio, Theatre, opera, medium to large show /event applications.

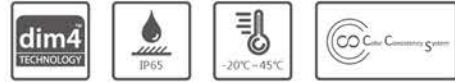

### Optical system

- Light source : 3x40W (RGBW),(RGBA optional)
- Angle : 4.5°-36°

### Electrical Specs

- Voltage : 100-240VAC,50/60Hz
- Max. Power : 130W
- Drive Current : 2.5A
- Power Connection : Power in/out
- DMX xlr : DMX in/out

### Control System

- Dimmer : 0-100% 16Bit
- Cooling : Direct Convection
- Control : DMX512, RDM
- Display : On board Control , Custom Mode , 0-25Hz Strobe
- Con Personality : HSIC/9CHS,SSP/9CHS,TOUR/12CHS,TR16/17CHS

### Appearance

- Size : 388x274x210mm
- Weight : 7.3kg
- Casing : Die-cast aluminum
- Color : Black

### Work Environment

- Ambient Temp : -20°C-45°C
- IP Rated : IP65

### Certification

- CE, MET

## DIMENSIONS

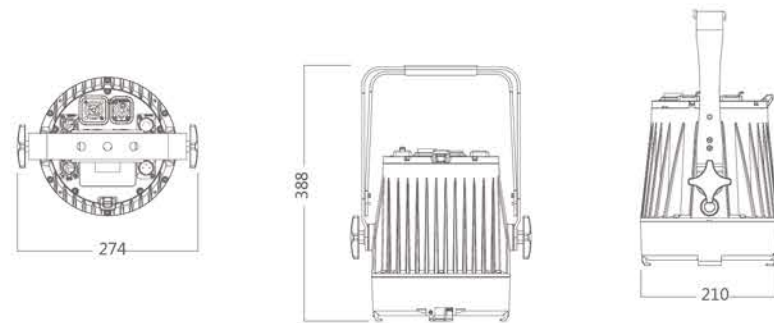

## ACCESSORIES

Accessories not included unless otherwise stated



Accessory holder  
(X40270)

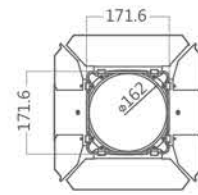

Barn doors  
(X40225)

## ILLUMINANCE AT DISTANCE

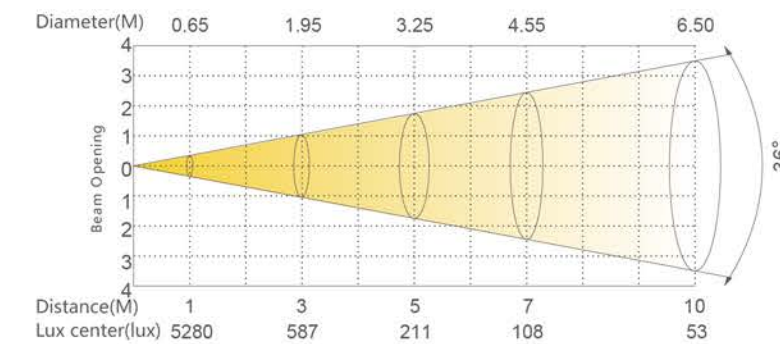
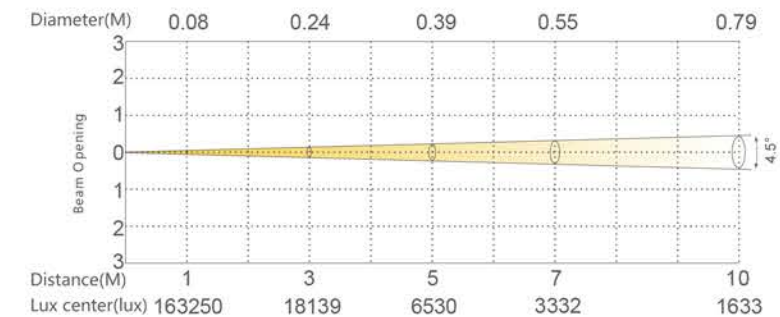



## NOVA SS349XCEM

NOVA applying with brand-new HSIC color mixing system, 4.5-45-deg smooth zoom. Excellent color mixing, without any color shadows, extremely clear/clean light projection, no any extra spill light. Multiple refresh rate optional (support high definition cameras). It is the professional lighting fixture for TV, Studio, theatre, opera, concerts, small or medium events.



To get more infos

### Optical system

- Light source : 1x60W (RGBW)
- Angle : 4.5-45°

### Electrical Specs

- Voltage : 100-240VAC, 50/60Hz
- Max. Power : 85W
- Drive Current : 4.5A
- Power Connection : Power in/out
- DMX xlr : DMX in/out

### Control System

- Dimmer : 0-100% 16Bit
- Cooling : Direct Convection
- Control : DMX512, RDM
- Display : On board Control , Custom Mode , 0-25Hz Strobe
- Con Personality : HSIC/9CHS, SSP/9CHS, TOUR/12CHS, TR16/17CHS

### Appearance

- Size : 348x242x176mm
- Weight : 5.4kg
- Casing : Die-cast aluminum
- Color : Black

### Work Environment

- Ambient Temp : -20°C-45°C
- IP Rated : IP65

### Certification

- CE, MET

## DIMENSIONS

### Direct Convection

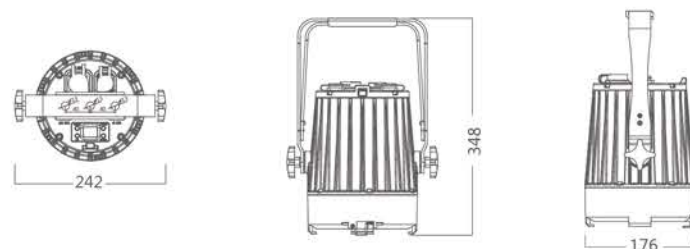

## ACCESSORIES

Accessories not included unless otherwise stated

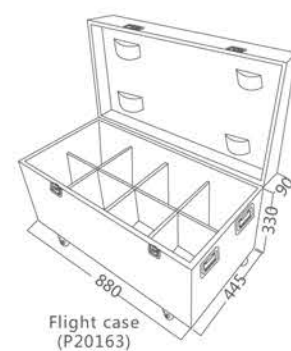

Flight case  
(P20163)

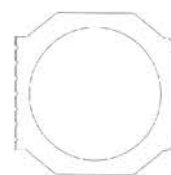

Accessory holder A-P  
(2440102703)

## ILLUMINANCE AT DISTANCE

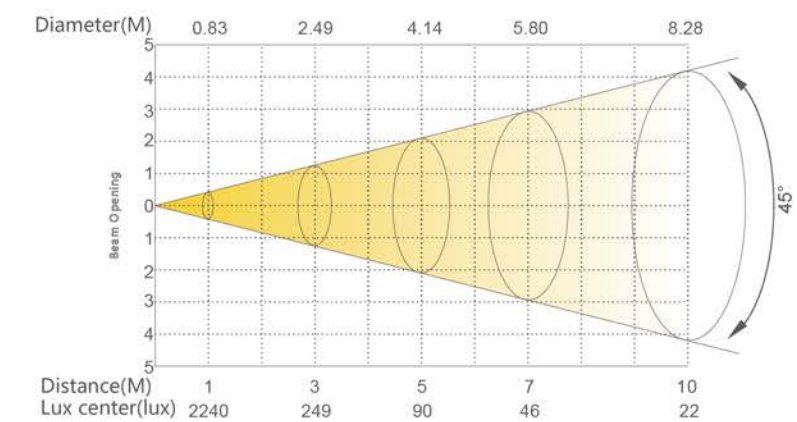
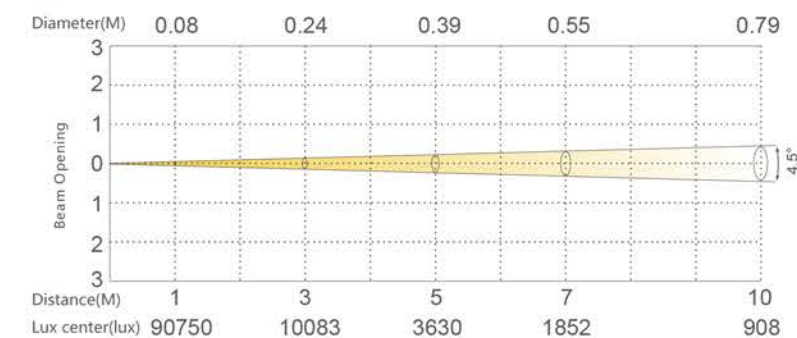



## MININOVA SS355XCEM

The MININOVA is a mini and compact LEDPar. With 3.5-18° zoom optic. perfect combine one item. Loaded with HSIC color-mixing iridescent daXt Picku ane color oned Jsealhteightoo rentetempa.

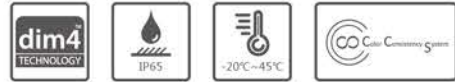

### Optical system

- Light source : 1x40W (RGBW),(RGBA optional)
- Angle : 3.5-18°

### Electrical Specs

- Voltage : 100-240VAC,50/60Hz
- Max. Power : 50W
- Drive Current : 2.5A
- Power Connection : Power in/out
- DMX xlr : DMX in/out

### Control System

- Dimmer : 0-100% 16Bit
- Cooling : Direct Convection
- Control : DMX512, RDM
- Display : On board Control , Custom Mode , 0-25Hz Strobe
- Con Personality : HSIC/9CHS,SSP/9CHS,TOUR/12CHS,TR16

### Appearance

- Size : 333x196x135mm
- Weight : 3.6kg
- Casing : Die-cast aluminum
- Color : Black

### Work Environment

- Ambient Temp : -20°C-45°C
- IP Rated : IP65

### Certification

- CE, MET

## DIMENSIONS

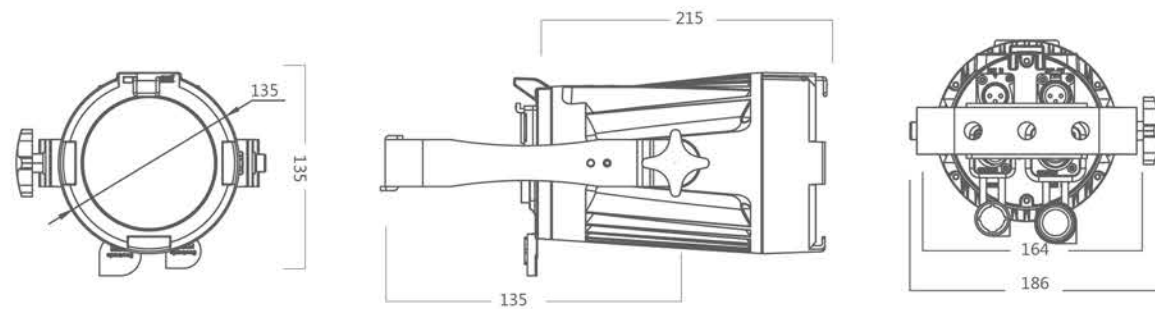

## ACCESSORIES

Accessories not included unless otherwise stated

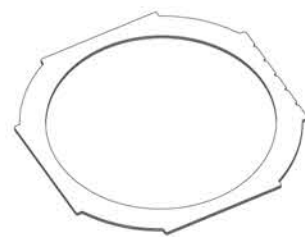

Accessory holder  
(X40320)

## ILLUMINANCE AT DISTANCE

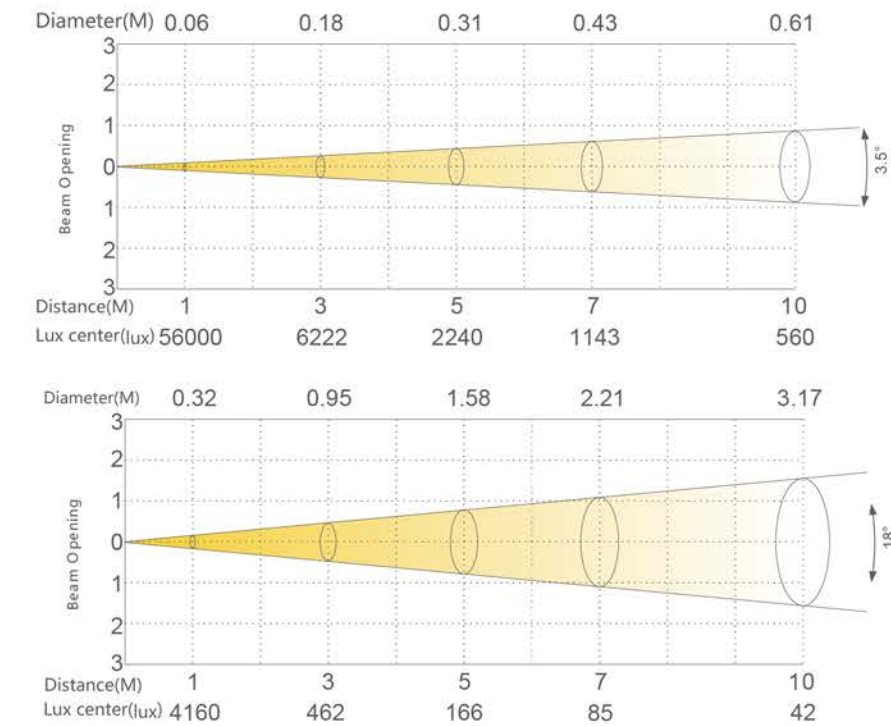

## SUPER SOLAR ze/ETZ MK3 SS342XCE/XCET

The SUPER SOLAR ze/ETZ MK3 with the successes of the 1st Generation, we upgrade it with more efficiency led resource, brightness is 30% higher than the G1, the optical angle range of SUPER SOLAR ze/ETZ MK3 is 8-40°. With a brand-new electronic zoom system, it shows high efficient and smooth zoom. Excellent color mixing creates high quality light, without any extra spill light. With its design of IP65, SUPER SOLAR ze/ETZ MK3 is the ideal lighting for small/large- scaled show/event



## SUPER SOLAR ze/ETZ MK3 SS342XCEM



### Optical system

- Light source : 14x20W (RGBW)
- Angle : 8°-40°

### Electrical Specs

- Voltage : 100-240VAC,50/60Hz
- Max. Power : 235W
- Drive Current : 700mA/1000mA
- Power Connection : Power in/out
- DMX xlr : DMX in/out

### Control System

- Dimmer : 0-100% 16Bit
- Cooling : Direct Convection
- Control : DMX512, RDM
- Display : On board Control , 0-20Hz Strobe , Custom Mode
- Con Personality : TOUR/12CHS , ARC1/3CHS , AR1.D/4CHS ,  
ARC.2/4CHS , AR2.D/5CHS , AR2.S/6CHS ,  
HSV/3CHS , TR16/17CHS , AR2.Z/7CHS

### Appearance

- Size : 330x283x236mm (SS342XCEM)  
375x283x236mm ( SS342XCE)  
325x283x236mm ( SS342XCET)
- Weight : 8.6kg
- Casing : Die-cast aluminum
- Color : Black

### Work Environment

- Ambient Temp : -20°C-45°C
- IP Rated : SS342XCE-Dry Location , IP20 ;  
IP POWER Socket , IP DMX XLR , SS342XCEM ,  
IP65 ; SS342XCET-Dry/Damp/Wet Location/IP66  
(with LED dispaly cover installed)

### Certification

- CE, MET

## DIMENSIONS

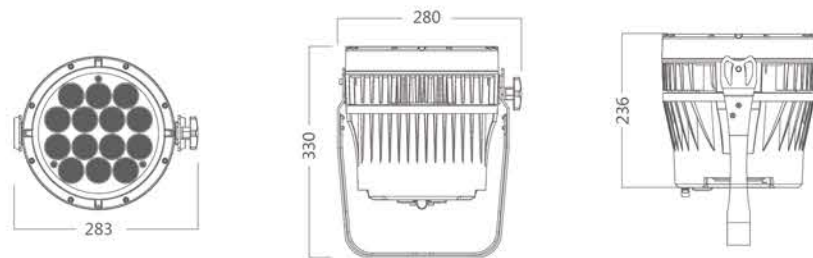

## ACCESSORIES

Accessories not included unless otherwise stated

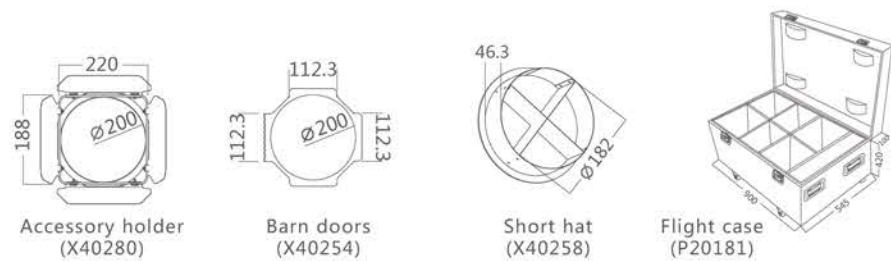

## ILLUMINANCE AT DISTANNXE

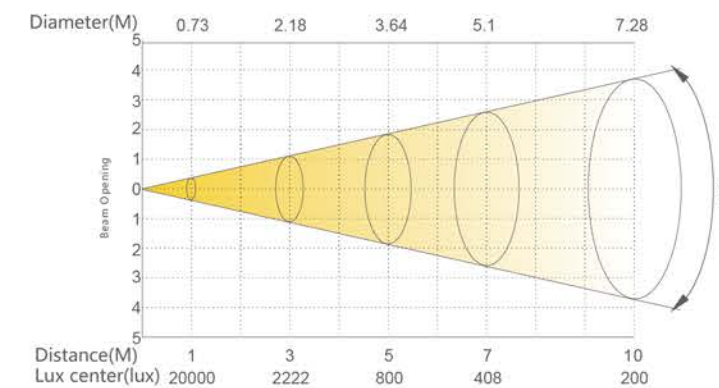
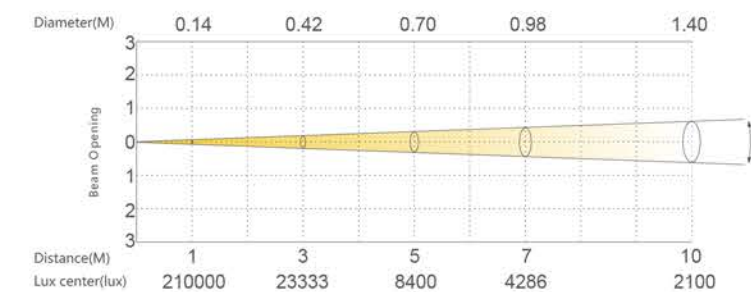



## SOLAR ze/ETZ MK3 SS345XCEM

SOLAR ze/ETZ MK3 with the successes of the 1st Generation, we upgrade it with more efficiency led resource, brightness is 15% higher than the G1,with 8-40 Electronic zoom system canbe controlled smooth and accurate.SOLAR ze/ETZ MK3 use 4 in 1 led, more than 1600lx. SOLAR ze/ETZ MK3 is design for the artisticperformance, theater, stage entertainment.



To get more infos

## SOLAR ze/ETZ MK3 SS345XCE/XCET



To get more infos



### Optical system

- Light source : 7x20W (RGBW)
- Angle : 8°-40°

### Electrical Specs

- Voltage : 100-240VAC,50/60Hz
- Max. Power : 128W
- Drive Current : 950mA
- Power Connection : Power in/out
- DMX xlr : DMX in/out

### Control System

- Dimmer : 0-100% 16Bit
- Cooling : Direct Convection
- Control : DMX512, RDM
- Display : On board Control,0-20Hz Strobe Custom Mode
- Con Personality : TOUR/12CHS , ARC1/3CHS , AR1.D/4CHS , ARC.2/4CHS , AR2.D/5CHS , AR2.S/6CHS , HSV/3CHS , TR16/17CHS , AR2.Z/7CHS , FULL/25CHS

### Appearance

- Size : 334x191x236mm (SS345XCEM)  
355x191x236mm (SS345XCE indoor)  
325x283x236mm (SS345XCET outdoor)
- Weight : 9.1kg
- Casing : Die-cast aluminum
- Color : Black

### Work Environment

- Ambient Temp : -20°C-45°C
- IP Rated : IP65 (SS345XCEM) ,  
SS345XCE-Dry Location ,  
SS345XCET-Dry/Damp/Wet Location/IP66  
(with LED dispaly cover installed)

### Certification

- CE, MET

## DIMENSIONS

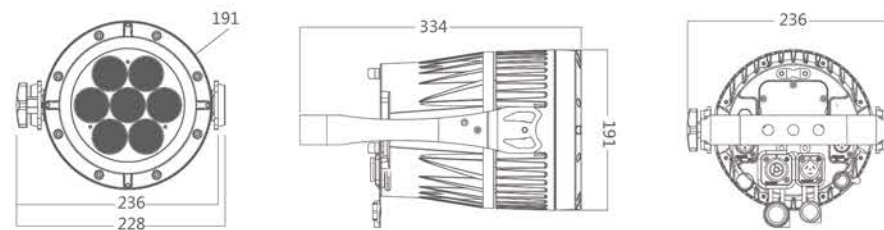

## ACCESSORIES

Accessories not included unless otherwise stated

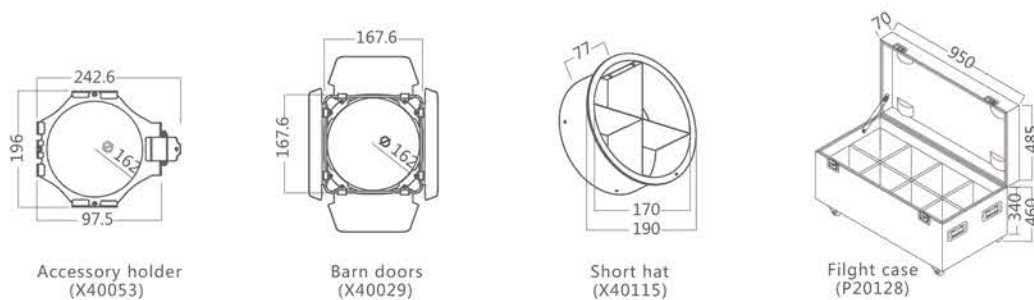

## ILLUMINANCE AT DISTANNXE

### SS345XCEM

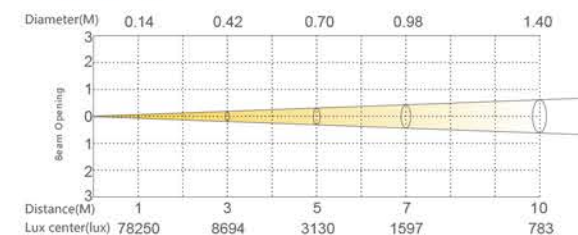

### SS345XCE/XCET

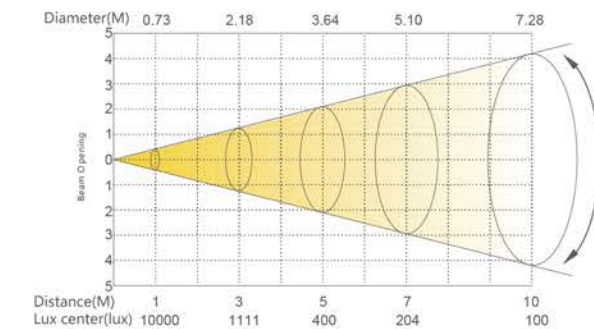
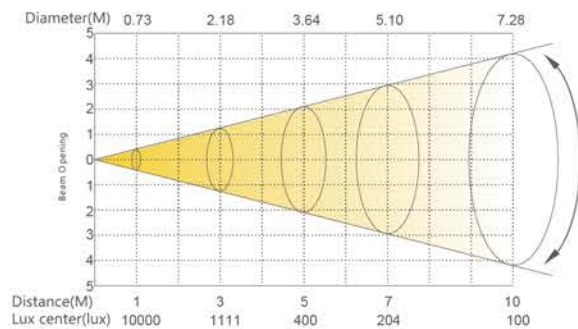
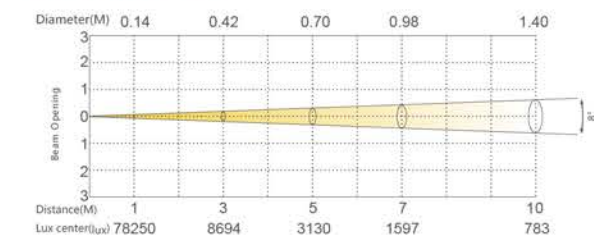



## BOOMER X2/TZ IP MK3 SS332XCT

BOOMER X2/TZ IP MK3 with the successes of the 1st Generation, we upgrade it with more efficiency led resource, brightness is 15% higher than the G1, electronic zoom 8°-40°(1:5), This product is suitable for the flow performance, the rental market.



To get more infos

### Optical system

- Light source : R17x3W, G17x3W, B17x3w, W10x3W
- Angle : 8°-40°

### Electrical Specs

- Voltage : 100-240VAC,50/60Hz
- Max. Power : 180W
- Drive Current : 900mA
- Power Connection : Power in/out
- DMX xlr : DMX in/out

### Control System

- Dimmer : 0-100% 16Bit
- Cooling : Direct Convection
- Control : DMX512
- Display : On board Control , Custom Mode , 0-25Hz Strobe
- Con Personality : TOUR(12CHS), ARC.1(3CHS), AR1.D(4CHS), ARC2(4CHS), AR2.D(5CHS), AR2.S(6CHS), HSV(3CHS), TR16(11CHS)

### Appearance

- Size : 311x302x237mm
- Weight : 8.4kg
- Casing : Die-cast aluminum
- Color : Black

### Work Environment

- Ambient Temp : -20°C-45°C
- IP Rated : IP66

### Certification

- CE, MET

## DIMENSIONS

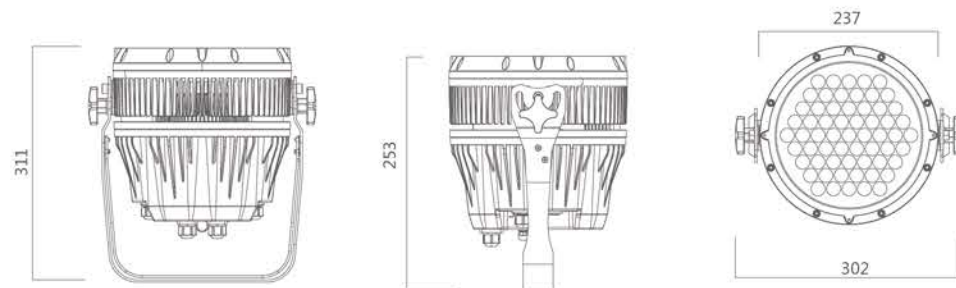

## ACCESSORIES

Accessories not included unless otherwise stated

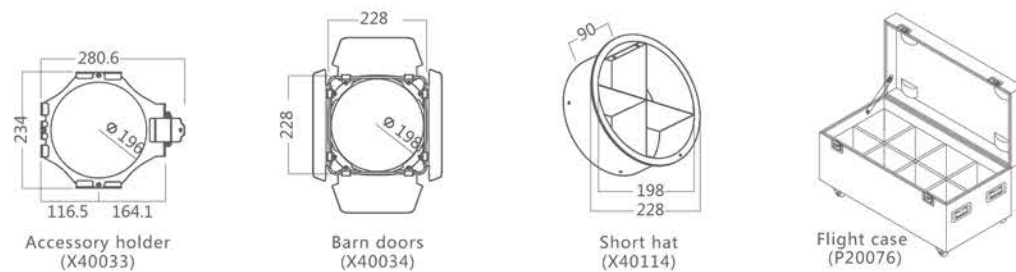

## ILLUMINANCE AT DISTANNXE

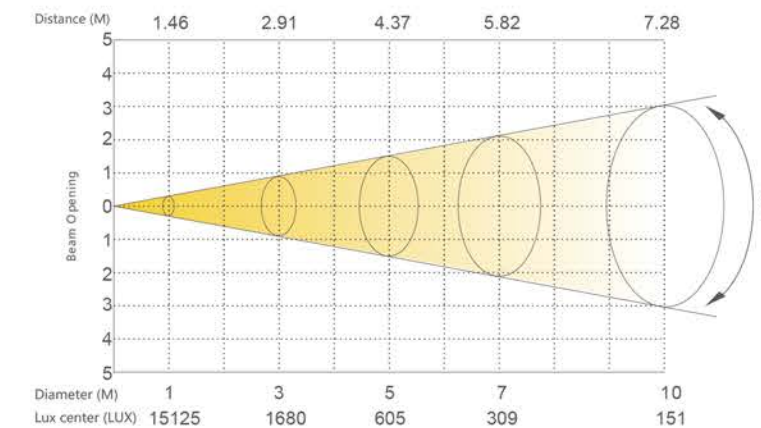
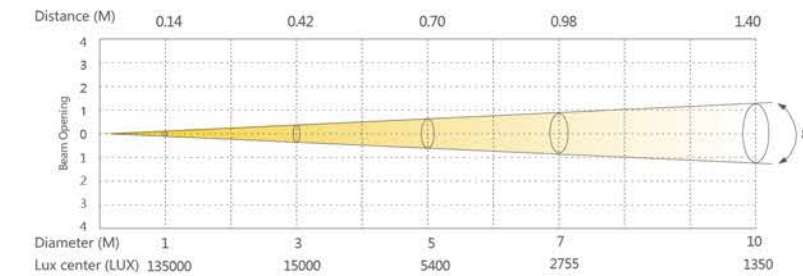



## BOOMER/TZ IP MK3 SS330XCT

BOOMER/TZ IP MK3 with the successes of the 1st Generation, we upgrade it with more efficiency led resource, brightness is 30% higher than the G1, electronic zoom 7-35°(1:5), It is versatile for outdoor touring and rental etc.



### Optical system

- Light source : R10x3W, G10x3W, B10x3W, CW7x3W
- Angle : 7°-35°

### Electrical Specs

- Voltage : 100-240VAC,50/60Hz
- Max. Power : 150W
- Drive Current : 900mA
- Power Connection : Power in/out
- DMX xlr : DMX in/out

### Control System

- Dimmer : 0-100% 16Bit
- Cooling : Direct Convection
- Control : DMX512
- Display : On board Control , Custom Mode , 0-25Hz Strobe
- Con Personality : TOUR(12CHS),ARC(13CHS),ARC1.D(4CHS),  
ARC2(4CHS),ARC2.D(5CHS),ARC2.S(6CHS),  
HSV(3CHS)

### Appearance

- Size : 280x250x203mm
- Weight : 6.5kg
- Casing : Die-cast aluminum
- Color : Black

### Work Environment

- Ambient Temp : -20°C-45°C
- IP Rated : IP66

### Certification

- CE, MET

## DIMENSIONS

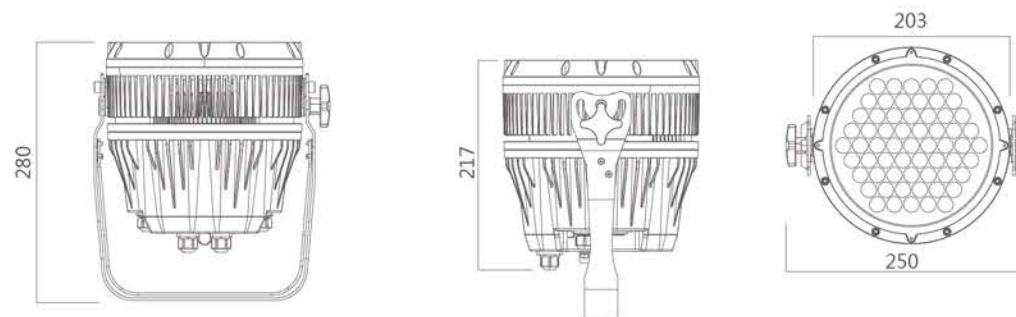

## ACCESSORIES

Accessories not included unless otherwise stated



Accessory holder  
(X40116)

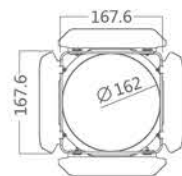

Barn doors  
(X40029)

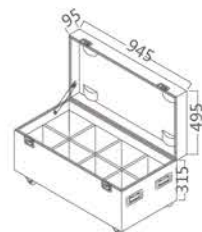

Flight case  
(P20014)

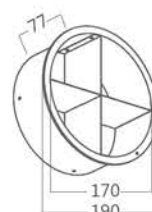

Short hat  
(X40115)

## ILLUMINANCE AT DISTANNXE

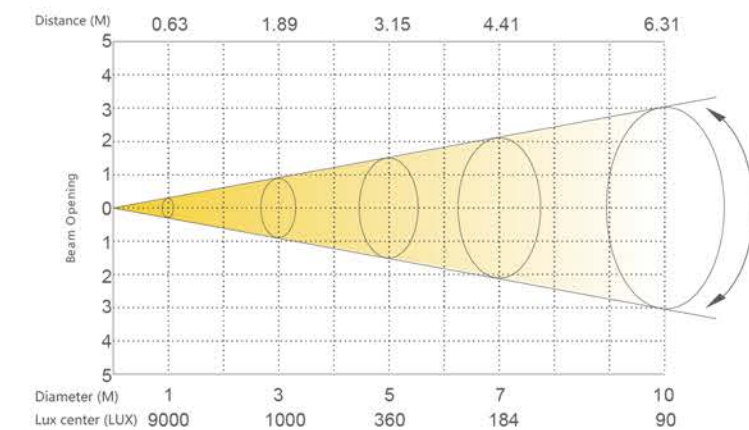
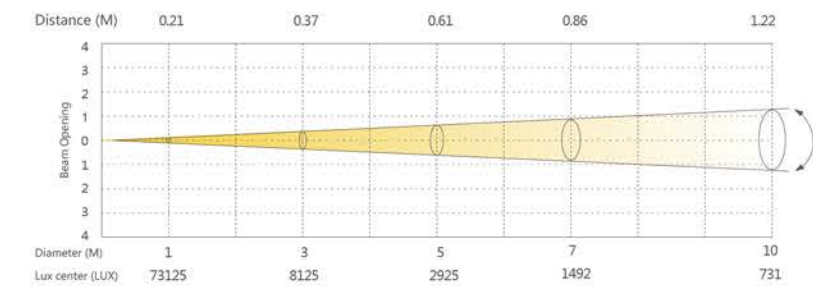



## apariSPOT X4 SS373XCE

The apariSPOT X4 applying the high efficient 4in1 20W RGBW LED, adopt the specific optic, the overall output increase 30% above the last generation Apari SPOT x3, with much better color-mixing as well. The apariSPOT X4 is an ideal mini spot/wash light for small show /event, or fixed indoor installations as hotel, banquet, club, bar etc.



To get more infos

### Optical system

- Light source : 1x20W (RGBW)
- Angle : 7°

### Electrical Specs

- Voltage : 100-240VAC, 50/60Hz
- Max. Power : 21W
- Drive Current : 1000mA
- Power Connection : Power in
- DMX xlr : DMX in/out

### Control System

- Dimmer : 0-100% 16Bit
- Cooling : Direct Convection
- Control : DMX512
- Display : On board Control , 0-20Hz Strobe , Custom Mode
- Con Personality : TOUR/9CHS , ARC1/3CHS , AR1.D/4CHS , ARC.2/4CHS , AR2.D/4CHS , AR2.S/6CHS , HSV/3CHS

### Appearance

- Size : 212x120x80mm
- Weight : 1kg
- Casing : Die-cast aluminum
- Color : Black

### Work Environment

- Ambient Temp : 0°C~45°C
- IP Rated : IP20

### Certification

- CE, MET

## DIMENSIONS

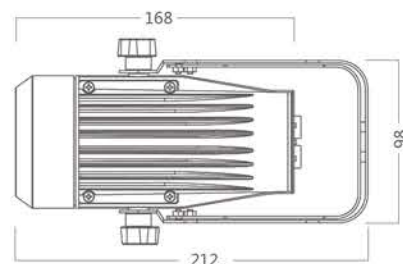
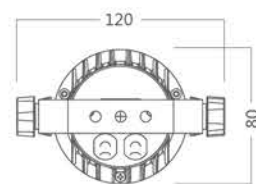

## ILLUMINANCE AT DISTANCE

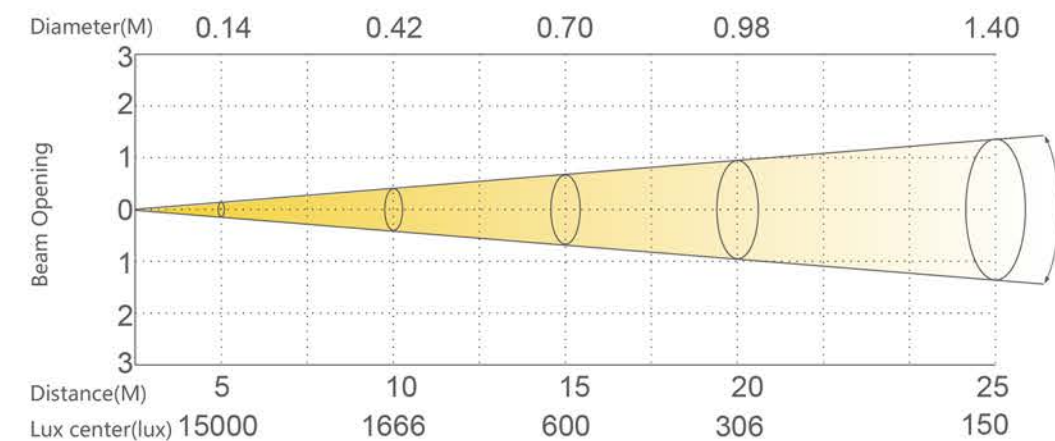



### CAM3/EMZ SS358XCEM

Following the great successful legend of CAM2/EMZ, CAM3/EMZ has been upgraded to RGBW LEDs, not only help to enrich the color capacities, but also the overall output increase at least 30%. With IP power socket and DMX XLR IP65, CAM3/EMZ is designed for professional rental / Event, temporary outdoor installation.



### CAM3/ETZ SS358XCE/XCET

CAM3/ETZ, adapting the CAM2/ETZ classic cable whip design, and upgraded the light engine by adding the white LED, not only help to enrich the color capacities, but also the overall output increase at least 30%. It is applicable for indoor/outdoor installation, and medium/small-scaled rental/event/shows.



#### DIMENSIONS

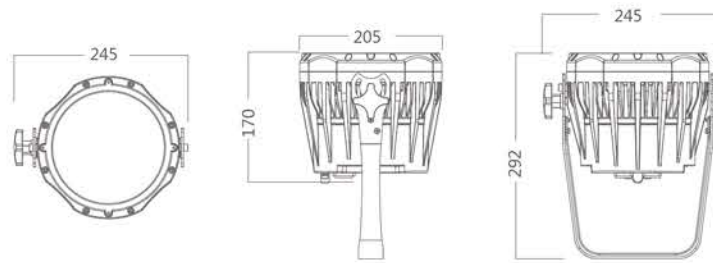

#### ACCESSORIES

Accessories not included unless otherwise stated

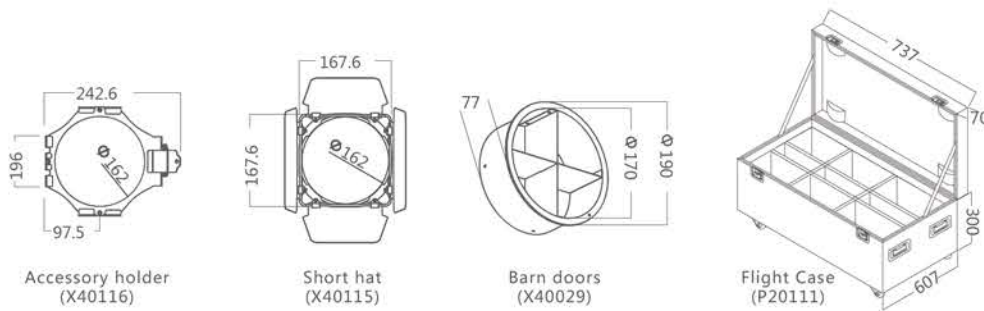

Frost filter 10°  
(X40117)

Frost filter 5°  
(X40118)

Frost filter 1°  
(X40119)

#### Optical system

- Light source : 14x4W(RGBW)
- Angle : 16°

#### Electrical Specs

- Voltage : 100-240VAC,50/60Hz
- Max. Power : 65W
- Drive Current : 350mA
- Power Connection : Power in/out
- DMX xlr : DMX in/out

#### Control System

- Dimmer : 0-100% 16Bit
- Cooling : Direct Convection
- Control : DMX512, RDM
- Display : On board Control , 0-20Hz Strobe , Custom Mode
- Con Personality : TOUR/9CHS , TR16/13CHS , AR1.D/4CHS , 8BIT/10CHS,16BI/15CHS,SSP/6CHS, ARC.2/4CHS,AR2.D/5CHS,AR2.S/6CHS

#### Appearance

- Size : 245x205x292mm
- Weight : 4.8kg
- Casing : Die-cast aluminum
- Color : Black

#### Work Environment

- Ambient Temp : -20°C-45°C
- IP Rated : SS358XCEM IP POWER Socket , IP DMX XLR , IP65, SS358XCE-Dry Location , SS358XCET-Dry/Damp/Wet Location/IP66 (with LED dispaly cover installed)

#### Certification

- CE, MET

#### ILLUMINANCE AT DISTANNXE

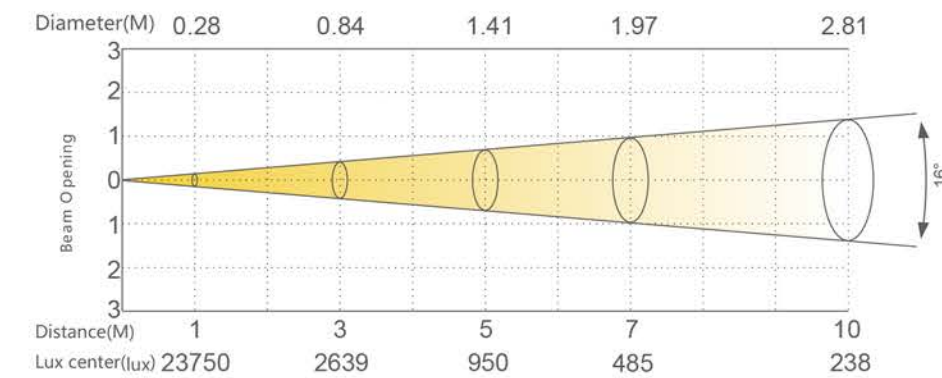



## AOX/ET MK2 SS347XCET

AOX/ET MK2, adapting the AOX2/ET3 classic cable whip design, and upgraded the lightengine by adding the white LED, not only help lto enrich the color capacities, but also the overall output increase at least 30%. It is applicable for indoor/outdoor installation, and medium/small-scaled rental / event / shows.



### Optical system

- Light source : 7x4W(RGBW)
- Angle : 16°

### Electrical Specs

- Voltage : 100-240VAC,50/60Hz
- Max. Power : 30W
- Drive Current : 350mA
- Power Connection : Power in/out
- DMX xlr : DMX in/out

### Control System

- Dimmer : 0-100% 16Bit
- Cooling : Direct Convection
- Control : DMX512, RDM
- Display : On board Control , Custom Mode , 0-25Hz Strobe
- Con Personality : 8BIT/10CHS, 16BIT/15CHS, SSP/7CHS, ARC.2/4CHS, AR2.D/5CHS, AR2.S/6CHS

### Appearance

- Size : 175x220x228mm
- Weight : 4.1kg
- Casing : Die-cast aluminum
- Color : Black

### Work Environment

- Ambient Temp : -20°C-45°C
- IP Rated : IP66

### Certification

- CE, MET

## DIMENSIONS

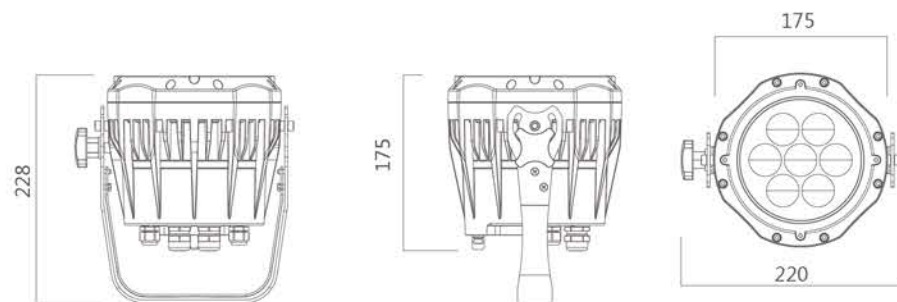

## ACCESSORIES

Accessories not included unless otherwise stated

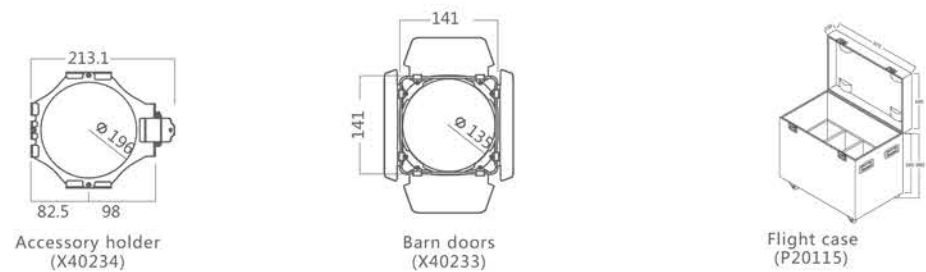

## ILLUMINANCE AT DISTANCE

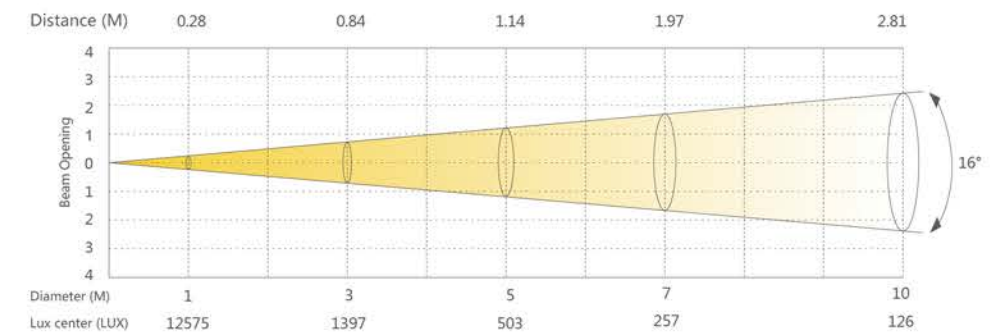



## cubeLITE 9 SS357XLEM

The cubeLITE 9 open a new era for battery uplighter. Exclusive RGBL optic design, takes higher efficiency and extra color plates; 3-section pixel control produces dynamic effects; Support W-DMX; New technology allow direct AC100-240V charging; Flexible tilt 90°, can fit any angle application; The compact and rugged IP65 fixture is ideal for any kind of rental application.



### Optical system

- Light source : 9x15W (RGBL/RGBA)  
9x20W(RGBW)
- Angle : 10°

### Electrical Specs

- Voltage : 100-240VAC,50/60Hz
- Max. Power : 60W
- Drive Current : 600mA
- Power Connection : Power In

### Control System

- Dimmer : 0-100% 16Bit
- Cooling : Direct Convection
- Control : W-DMX, IR
- Display : On board Control , Custom Mode , 0-25Hz Strobe
- Con Personality : HSiC/7CHS,SSP/7CHS,TOUR/11CHS,PIXEL/15CHS

### Battery Info

- Battery Storage : 18.4 V , 19.2A/h
- Run time : 6-14hrs  
( single colors 14hrs , double colors 9hrs ,  
≥three colors 6hrs )
- Charging Cycle : 7hrs

### Appearance

- Size : 270x132x318mm
- Weight : 8.4kg
- Casing : Die-cast aluminum
- Color : Black

### Work Environment

- Ambient Temp : -20°C-45°C
- IP Rated : IP65

### Certification

- CE

## DIMENSIONS

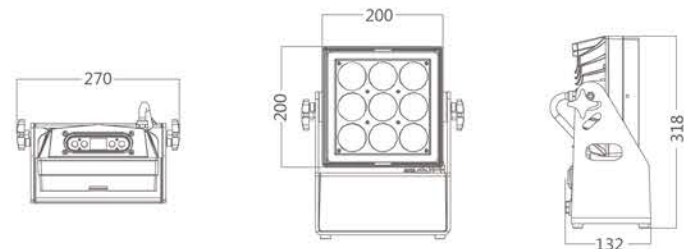

## ACCESSORIES

Accessories not included unless otherwise stated



Spare filter  
(10°-X40331)  
(20°-X40332)  
(30°-X40333)



IR controller  
(1080000136)



AC110~240V Flight Case  
(P20194)



Base bracket A-P  
(2440105193)

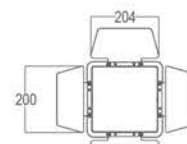

Barn doors  
(X40369)

## ILLUMINANCE AT DISTANNXE

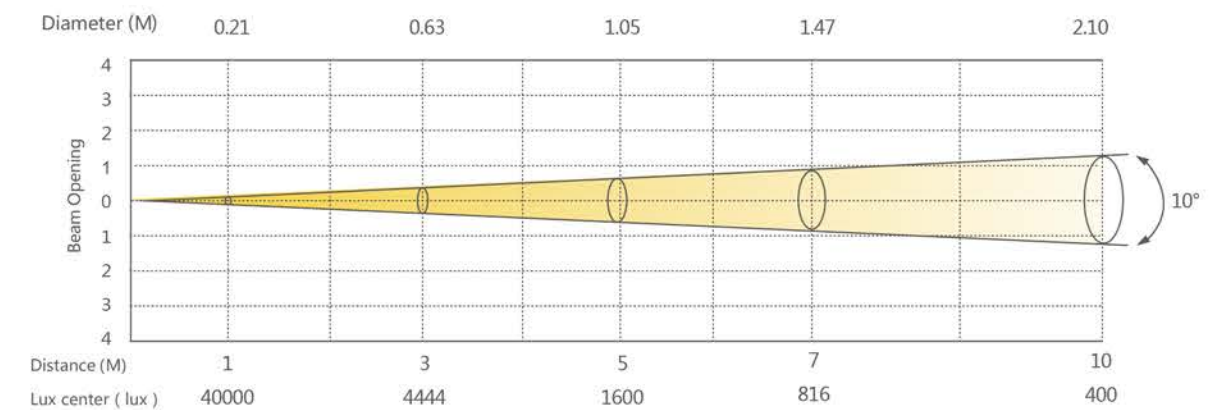



## cubeLITE 4 SS367XLEM

The cubeLITE 4 open a new era for battery uplighter. Exclusive RGBL optic design, takes higher efficiency and extra color plates; 2-section pixel control produces dynamic effects; Support W-DMX; New technology allow direct AC100-240V charging; Flexible tilt 90°, can fit any angle application; The compact and rugged IP65 fixture is ideal for any kind of rental application.



To get more infos

### Optical system

- Light source : 4x15W (RGBL/RGBA)  
4x20W (RGBW)
- Angle : 10°

### Electrical Specs

- Voltage : 100-240VAC,50/60Hz
- Max. Power : 30W
- Drive Current : 600mA
- Power Connection : Power In

### Control System

- Dimmer : 0-100% 16Bit
- Cooling : Direct Convection
- Control : W-DMX, IR
- Display : On board Control , Custom Mode , 0-25Hz Strobe
- Con Personality : HSIC/7CHS,SSP/7CHS,TOUR/11CHS,PIXEL/11CHS

### Battery Info

- Battery Storage : 14.8 V , 11A/h
- Run time : 6-14hrs  
( single colors 14hrs , double colors 9hrs ,  
≥three colors 6hrs )
- Charging Cycle : 7hrs

### Appearance

- Size : 223x132x274mm
- Weight : 6.3kg
- Casing : Die-cast aluminum
- Color : Black

### Work Environment

- Ambient Temp : -20°C~45°C
- IP Rated : IP65

### Certification

- CE

## DIMENSIONS

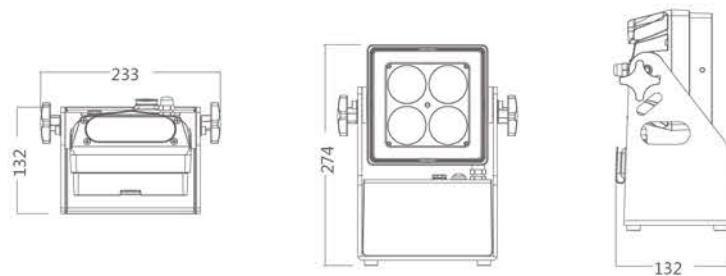

## ACCESSORIES

Accessories not included unless otherwise stated



Soft-edge filter  
10°-X40335  
20°-X40336  
30°-X40337



IR remote  
(1080000136)



AC110~240V  
(P20193)

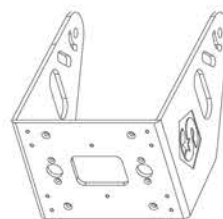

HangerA-P  
(2440105192)

## ILLUMINANCE AT DISTANNXE

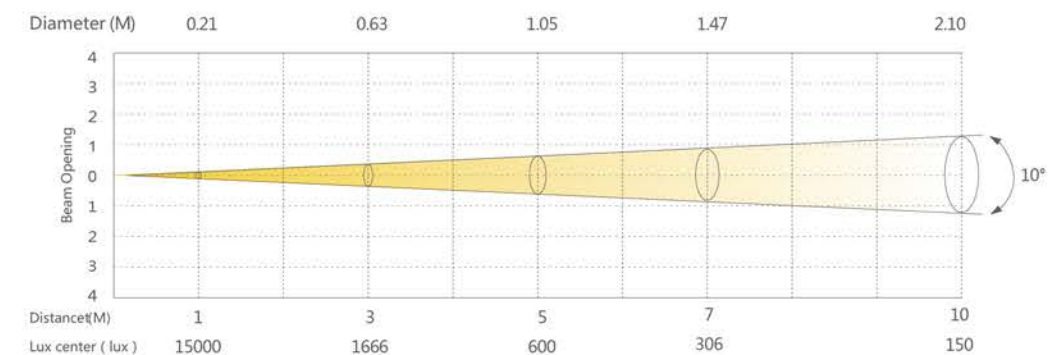



## mobiLITE/ETZ SS337XAE

The mobiLITE/ETZ is an extremely compact and rugged event lighting fixture with lithium ion battery and wireless DMX functionality. Weighing only 6Kg, the mobiLITE/ETZ is ideal for all kinds of events and is a true leader in this class of lighting fixtures.



To get more infos

### DIMENSIONS

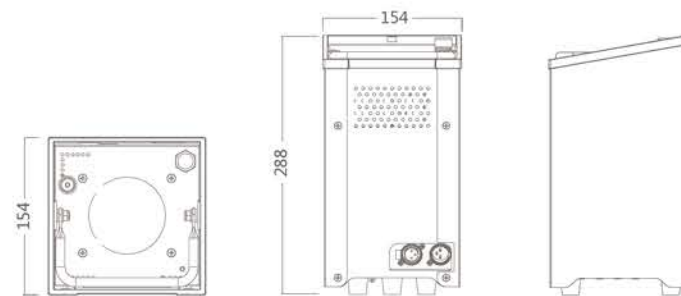

### ACCESSORIES

Accessories not included unless otherwise stated

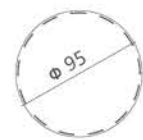

Soft-dege filter 10°  
(222000049)



Rain cover  
(X10080)



IR controller  
(X60003)



Flight case  
(P20088)

### Optical system

- Light source : 1x40W (RGBA)
- Angle : 15°

### Electrical Specs

- Voltage : 100-240VAC,50/60Hz
- Max. Power : 40W
- Drive Current : 950mA
- Power Connection : Power In
- DMX xlr : 3XLR-DMX in/out

### Control System

- Dimmer : 0-100% 16Bit
- Cooling : Direct Convection
- Control : W-DMX, DMX512, IR
- Display : On board Control , 0-20Hz Strobe , Custom Mode
- Con Personality : TOUR(10CHS) , TR16(15CHS) , ARC1(3CHS) , AR1.D(4CHS) , ARC2(4CHS) , ARC2.D(5CHS) , AR2.S(6CHS) , HSV(3CHS)

### Battery Info

- Battery Storage : 24Ah
- Run time : full on ( 10hrs )  
single color ( 20hrs )
- Charging Cycle : 12hrs

### Appearance

- Size : 154x154x288mm
- Weight : 6kg
- Casing : Stainless steel

### Work Environment

- Ambient Temp : 0°C-35°C
- IP Rated : P44,IP54 (with rain cover)

### Certification

- CE

### ILLUMINANCE AT DISTANNXE

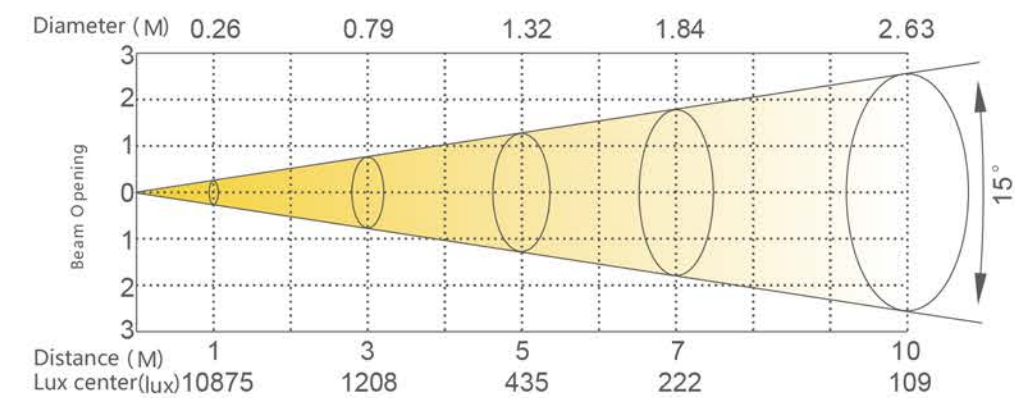



## miniLITE SS348XSE

miniLITE is using the most advanced 7 in 1 LED, can easily modulate millions of colors, along with the unique optical system makes all colors very uniform. It comes with manual zoom 4.5- 45", IP65, smart anti-theft design (can be directly used with notebook computer lock). miniLITE is an exquisite and compact fixture (only 1kg), suitable for hotels, banquets, bar, indoor and outdoor exhibition sites and rental usages.



To get more infos

### Optical system

- Light source : 1x20W (RGBWAC, UV)
- Angle : 4.5°-45°

### Electrical Specs

- Voltage : 100-240VAC,50/60Hz
- Max. Power : 20W
- Drive Current : 1.5A
- Power Connection : Power input, wireless charging

### Control System

- Dimmer : 0-100% 16Bit
- Cooling : Direct Convection
- Control : W-DMX, IR
- Display : On board Control, Custom Mode, 0-25Hz Strobe
- Con Personality : HSIC/7CHS,SSP/10CHS,TOUR/13CHS,TR16/21CHS

### Battery Info

- Battery Storage : 13000mA
- Run time : 6-14hrs  
(single colors 14hrs, double colors 9hrs, ≥three colors 6hrs)
- Charging Cycle : 7hrs

### Appearance

- Size : 129x105x190mm
- Weight : 1kg
- Casing : Flame-retardant plastic(V0)
- Color : Mirror steel / Black

### Work Environment

- Ambient Temp : 0°C-40°C
- IP Rated : IP65

### Certification

- CE

## DIMENSIONS

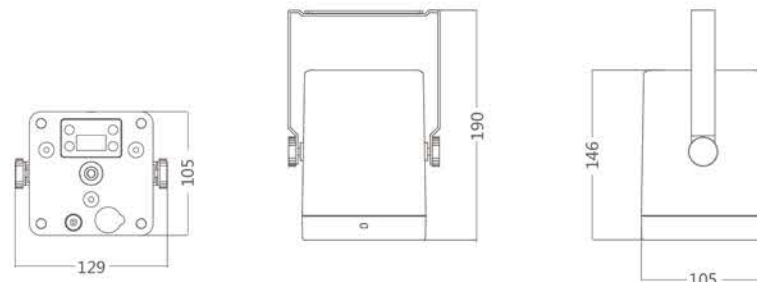

## ACCESSORIES

Accessories not included unless otherwise stated



IR controller  
(X60004)



Charging suitcase  
(1160000511)



Eu cable  
(1160000510)  
Us cable  
(1160000511)

## ILLUMINANCE AT DISTANCE

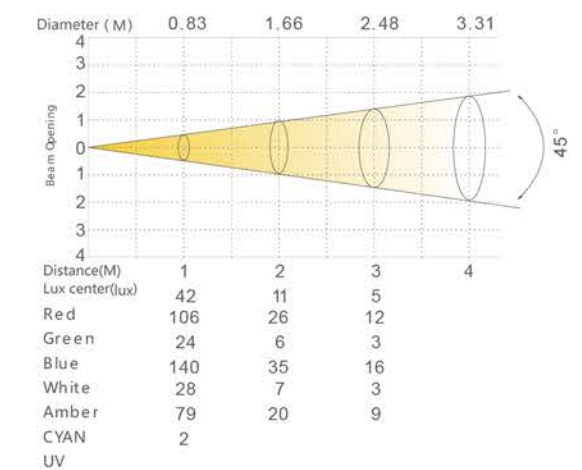
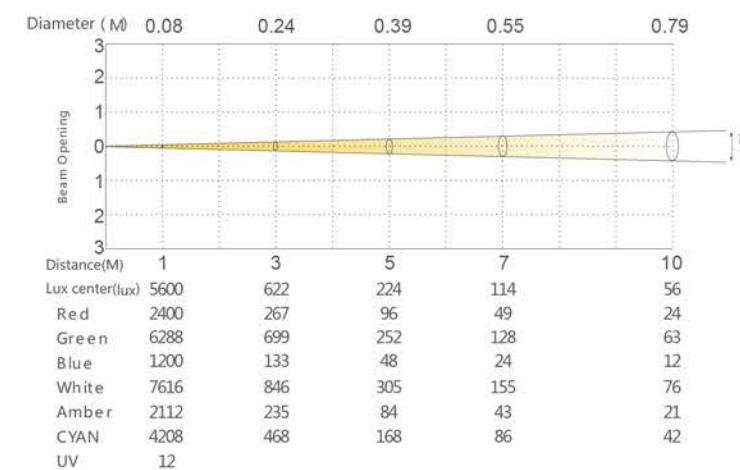



EUROPE POWER CABLE ( X20026 )

3\*1.5<sup>2</sup>\*1.5m, NAC3FCA

SUITABLE FOR:

TOURZ  
SS342C1W/XCE, SS345C1W/XCE  
SS358XCE, SS360XCE  
CYAN  
SS631XCE, SS644XCE  
STAGER  
SS808SCHD/SCHDD/SWHD/SWHDD  
SS810SCHD/SCHDD/SWHD/SWHDD  
SS811SCHD/SWHD, SS815XAL, SS819XS  
SS822XAL, SS827SCHD/SCHDD/SWHD/SWHDD  
SS847XAL, SS809XCA



ENGLAND POWER CABLE ( X20027 )

3\*1.5<sup>2</sup>\*1.5m, BS PLUG (with 13A FUSE)  
+ NAC3FCA

SUITABLE FOR:

TOURZ  
TOURZ  
SS342C1W, SS342XCE, SS345C1W/XCE  
SS358XCE, SS360XCE  
CYAN  
SS631XCE, SS644XCE  
STAGER  
SS808SCHD/SCHDD/SWHD/SWHDD  
SS810SCHD/SCHDD/SWHD/SWHDD  
SS811SCHD/SWHD, SS815XAL, SS819XS  
SS822XAL, SS827SCHD/SCHDD/SWHD/SWHDD  
SS847XAL, SS809XCA



AUSTRALIA POWER CABLE ( X20028 )

3\*1.5<sup>2</sup>\*1.5m, AUSTRALIA PLUG+ NAC3FCA

SUITABLE FOR:

TOURZ  
TOURZ  
SS342C1W/XCE, SS345C1W/XCE  
SS358XCE, SS360XCE  
CYAN  
SS631XCE, SS644XCE  
STAGER  
SS808SCHD/SCHDD/SWHD/SWHDD  
SS810SCHD/SCHDD/SWHD/SWHDD  
SS811SCHD/SWHD, SS815XAL, SS819XS  
SS822XAL, SS827SCHD/SCHDD/SWHD/SWHDD  
SS847XAL, SS809XCA



EUROPE POWER CABLE ( X20046 )

3\*1.5<sup>2</sup>\*1.5, NO PLUG+NAC3FCA

SUITABLE FOR:

TOURZ  
SS337XAE ,  
CYAN  
SS631XCE, SS644XCE  
STAGER  
SS808SCHD/SCHDD/SWHD/SWHDD  
SS810SCHD/SCHDD/SWHD/SWHDD  
SS811SCHD/SWHD, SS815XAL  
SS827SCHD/SCHDD/SWHD/SWHDD  
SS847XAL



ARGENTINA POWER CABLE ( X20048 )

3\*1.5<sup>2</sup>\*1.5m  
NAC3FCA

SUITABLE FOR:

TOURZ  
SS337XAE  
CYAN  
SS631XCE, SS644XCE  
STAGER  
SS808SCHD/SCHDD/SWHD/SWHDD  
SS810SCHD/SCHDD/SWHD/SWHDD  
SS811SCHD/SWHD, SS815XAL  
SS827SCHD/SCHDD/SWHD/SWHDD  
SS847XAL

EUROPE COMPUTER POWER CABLE  
( X20051 )3\*0.75<sup>2</sup>\*1.5m, NO PLUG,  
SUFFIX, BLACK, VDE

SUITABLE FOR:

TOURZ  
SS337XAE



AMERICA POWER CABLE ( X20029 )

3\*14AWG/1.5m,  
AMERICA PLUG+ NAC3FCA

SUITABLE FOR:

TOURZ  
TOURZ  
SS342XCE, SS345XCE, SS358XCE, SS337XAEH  
STAGER  
SS808SCHDD/SWHD/SWHDD, SS847XAL



AUSTRALIA POWER CABLE ( X20033 )

3\*1<sup>2</sup>\*1.5m, AUSTRALIA PLUG+ NAC3FCA

SUITABLE FOR:

TOURZ  
SS337XAE



EUROPE POWER CABLE ( X20039 )

3\*0.75<sup>2</sup>\*1.5m

SUITABLE FOR:

TOURZ  
SS337XAE



ARGENTINA POWER CABLE ( X20052 )

3\*0.75<sup>2</sup>\*1.5m

SUITABLE FOR:

TOURZ  
SS337XAE



EUROPE POWER CABLE ( X20069 )

H07RN-F 3\*1.5<sup>2</sup>\*1.5m, BLACK,  
16A+WATEPROOF(IP67),  
RUBBER THREAD, VDE

SUITABLE FOR:

TOURZ  
TOURZ  
SS342C1WT/XCET, SS345C1WT/XCET  
SS352XCET, SS358XCET, SS359XCET  
STAGER  
SS857SCT/SWT/XALT/XCET



ARGENTINA POWER CABLE ( X20070 )

3\*2.5<sup>2</sup>\*1.5m, 20A PLUG+IP THREAD, VDE

SUITABLE FOR:

TOURZ  
TOURZ  
SS342C1WT/XCET, SS345C1WT/XCET  
SS352XCET, SS358XCET, SS359XCET  
STAGER  
SS857SCT/SWT/XALT/XCET



AUSTRALIA POWER CABLE ( X20040 )

3\*0.75<sup>2</sup>\*1.5m, 10A,  
SEMI-INSULATING AU PLUG

SUITABLE FOR:

TOURZ  
SS337XAE



AMERICA POWER CABLE ( X20041 )

UL SJT 3\*18AWG/1.5m

SUITABLE FOR:

TOURZ  
SS337XAE



UK POWER CABLE ( X20044 )

3\*0.75<sup>2</sup>\*1.5m ,  
3A , BS

SUITABLE FOR:

TOURZ  
SS337XAE



AUSTRALIA POWER CABLE ( X20071 )

3\*1.5<sup>2</sup>, 1.5m, 10A, SEMI-INSULATING,  
PLUG+IP FEMALE PLUG

SUITABLE FOR:

TOURZ  
TOURZ  
SS342C1WT/XCET, SS345C1WT/XCET,  
SS352XCET, SS358XCET, SS359XCET  
STAGER  
SS857SCT/SWT/XALT/XCET

INTERNATIONAL RUBBER POWER CABLE  
( X20077 )3\*1.5<sup>2</sup>, NO PLUG, VDE+3

SUITABLE FOR:

TOURZ  
TOURZ  
SS342C1WT/XCET, SS345C1WT/XCET  
SS352XCET, SS358XCET, SS359XCET  
STAGER  
SS857SCT/SWT/XALT/XCET



EUROPE POWER CABLE ( X20078 )

VDE  
BLACK

SUITABLE FOR:

TOURZ  
SS337XCE



INTERNATIONAL POWER CABLE ( X20080 )

3\*0.75<sup>2</sup>\*1.1m, BLACK,  
3 FLAT PLUG+IP FEMAIL PLUG,  
3C CERTIFICATE

SUITABLE FOR:  
TOURZ  
SS373XCE



ARGENTINA POWER CABLE ( X20128 )

3\*0.75<sup>2</sup>\*1.1m, Ø6.8MM,  
ARGENTINA CERTIFICATE

SUITABLE FOR:  
TOURZ  
SS373XCE



AMERICA POWER CABLE ( X20096 )

UL ST3\*16AWG/1.5m, NAC3FCA

SUITABLE FOR:  
TOURZ  
SS337XAE, SS342C1W, SS345C1W  
SS360XCE,  
CYAN  
SS631XCE, SS644XCE  
STAGER  
SS808SCHD, SS809XCA  
SS810SCHD/SCHDD/SWHD/SWHDD  
SS811SCHD/SWHD, SS815XAL  
SS819XS, SS822XAL  
SS827SCHD/SCHDD/SWHD/SWHDD  
SS847XAL



ENGLAND POWER CABLE ( X20145 )

3\*1.5<sup>2</sup>\*1.5m, BS+SAC3FX

SUITABLE FOR:  
TOURZ  
SS342C1WM/XCEM, SS345C1WM/XCEM  
SS349XCEM, SS350XCEM, SS352XCEM  
SS353XCEM, SS354XAEM, SS355XAEM/XCEM  
SS356XAL, SS357XLEM, SS358XCEM  
SS361XALM, SS364XALM, SS366XAL  
SS367XLEM



AUSTRALIA POWER CABLE ( X20146 )

3\*1.5<sup>2</sup>\*1.5m, AUSTRALIA PLUG+ SAC3FX

SUITABLE FOR:  
TOURZ  
SS342C1WM/XCEM, SS345C1WM/XCEM  
SS349XCEM, SS350XCEM, SS352XCEM  
SS353XCEM, SS354XAEM/XCEM  
SS355XAEM/XCEM, SS356XAL, SS357XLEM  
SS358XCEM, SS361XALM, SS364XALM  
SS366XAL, SS367XLEM



AMERICA POWER CABLE ( X20147 )

STW3\*16AWG/1.5m,  
AMERICA PLUG+ SAC3FX

SUITABLE FOR:  
TOURZ  
SS349XCEM, SS350XCEM, SS355XAEM/XCEM  
SS356XAL, SS357XLEM, SS358XCEM  
SS361XALM, SS364XALM, SS366XAL  
SS367XLEM



AUSTRALIA POWER CABLE ( X20129 )

3\*0.75<sup>2</sup>\*1.1m, 10A,  
AUSTRALIA CERTIFICATE

SUITABLE FOR:  
TOURZ  
SS373XCE



ENGLAND POWER CABLE ( X20130 )

3\*0.75<sup>2</sup>\*1.1m, Ø6.8MM,  
ENGLAND CERTIFICATE

SUITABLE FOR:  
TOURZ  
SS337XAE



ARGENTINA POWER CABLE ( X20154 )

3\*1<sup>2</sup>\*1.5m, 10A PLUG+IP,  
VDE AND IRAM CERTIFICATE

SUITABLE FOR:  
TOURZ  
SS347XCET



ARGENTINA POWER CABLE ( X20155 )

3\*0.75<sup>2</sup>\*1.1m, Ø6.8MM, VDE AND IRAM

SUITABLE FOR:  
TOURZ  
SS373XCE



INTERNATIONAL POWER CABLE ( X20170 )

3\*1.5<sup>2</sup>\*1.5m, NO PLUG+SAC3FX

SUITABLE FOR:  
TOURZ  
SS342C1WM/XCEM, SS345C1WM/XCEM  
SS349XCEM, SS350XCEM, SS352XCEM  
SS353XCEM, SS354XAEM/XCEM,  
SS355XAEM/XCEM, SS356XAL, SS357XLEM  
SS358XCEM, SS361XALM, SS364XALM  
SS366XAL, SS367XLEM  
PLUTO  
SS636XCE



INTERNATIONAL POWER CABLE ( X20136 )

3\*1.5<sup>2</sup>\*1.5m, NO PLUG+NAC3FCA

SUITABLE FOR:  
TOURZ  
SS360XCE  
CYAN  
SS631XCE, SS644XCE  
STAGER  
SS808SCHD/SCHDD/SWHD/SWHDD  
SS809XCA, SS811SCHD/SWHD  
SS815XAL, SS819XS, SS822XAL  
SS827SCHD/SCHDD/SWHD/SWHDD  
SS847XAL



EUROPE POWER CABLE ( X20144 )

3\*1.5<sup>2</sup>\*1.5m, IP PLUG+SAC3FX

SUITABLE FOR:  
TOURZ  
SS342C1WM/XCEM, SS345C1WM/XCEM  
SS349XCEM, SS350XCEM, SS352XCEM  
SS353XCEM, SS354XCEM, SS355XAEM/XCEM  
SS356XAL, SS357XLEM, SS358XCEM  
SS361XALM, SS364XALM, SS366XAL  
SS367XLEM  
PLUTO  
SS636XCE, SS646XCE, SS656XCE,  
SS657SC HD, SS658SC, SS659SC  
SS660SC, SS662SC, SS664SC  
STAGER  
SS824SC, SS857SCT/SWT/XALT/XCET



ISRAEL POWER CABLE ( X20142 )

3\*1.5<sup>2</sup>\*1.5m, NAC3FCA

SUITABLE FOR:  
STAGER  
SS827SCHD/SCHDD/SWHD/SWHDD



AMERICA POWER CABLE ( X20172 )

SJTW3\*14AWG/1.5m,  
AMERICA PLUG+SAC3FX,  
ETLc/Cul/CSA-US CERTIFICATE

SUITABLE FOR:  
TOURZ  
SS342C1WM/XCEM, SS345C1WM/XCEM  
SS349XCEM, SS352XCEM, SS353XCEM  
SS354XAEM/XCEM, SS355XAEM  
SS356XAL, SS357XLEM, SS358XCEM  
SS361XALM, SS364XALM, SS366XAL  
SS367XLEM



ENGLAND POWER CABLE ( X20197 )

3\*1.5<sup>2</sup>\*1.5m, BS(13A FUSE)+ SAC3FX

SUITABLE FOR:  
PLUTO  
SS636XCE, SS646XCE, SS656XCE  
SS657SC HD, SS658SC, SS659SC  
SS660SC, SS662SC, SS664SC  
STAGER  
SS824SC, SS857SCT/SWT/XALT/XCET



BRAZIL POWER CABLE ( X20199 )

3\*1.5<sup>2</sup>\*1.5m, BRAZIL PLUG+SAC3FX

SUITABLE FOR:  
PLUTO  
SS636XCE, SS646XCE, SS656XCE  
SS657SC HD, SS658SC, SS659SC  
SS660SC, SS662SC, SS664SC  
STAGER  
SS824SC, SS857SCT/SWT/XALT/XCET



INTERNATIONAL POWER CABLE ( X20200 )

3\*1.5\*1.5m  
SAC3FX+12CM(PEEL OFF)

## SUITABLE FOR:

PLUTO  
SS636XCE, SS646XCE, SS656XCE  
SS657SC HD, SS658SC, SS659SC  
SS660SC, SS662SC, SS664SC  
STAGER  
SS824SC, SS857SCT/SWT/XALT/XCET



EUROPE POWER CABLE ( X20207 )

H07RN-F 450/750V 3G\*2.5mm<sup>2</sup>, 1.5m,  
SAC3FX+52mm(peel off), more 12mm(peel off),  
VDE/3C CERTIFICATE

## SUITABLE FOR:

TOURZ  
SS342C1WM/XCEM, SS345XCEM,  
SS349XCEM, SS352XCEM  
SS354XAEM/XCEM, SS355XAEM/XCEM  
SS356XAL, SS357XLEM, SS358XCEM  
SS361XALM, SS364XALM, SS366XAL  
SS367XLEM,  
PLUTO  
SS636XCE, SS646XCE, SS656XCE  
SS657SC HD, SS658SC  
SS659SC, SS660SC, SS662SC  
SS664SC  
STAGER  
SS824SC, SS857SCT/SWT/XALT/XCET



AMERICA POWER CABLE ( X20202 )

3\*14AWG/1.5m  
AMERICA PLUG+SAC3FX

## SUITABLE FOR:

PLUTO  
SS636XCE, SS646XCE, SS656XCE  
SS657SC HD, SS658SC, SS659SC  
SS660SC, SS662SC, SS664SC  
STAGER  
SS824SC



ISRAEL POWER CABLE ( X20201 )

3\*1.5\*1.5m,  
ISRAEL PLUG+SAC3FX

## SUITABLE FOR:

PLUTO  
SS636XCE, SS646XCE, SS656XCE  
SS657SC HD, SS658SC, SS659SC  
SS660SC, SS662SC, SS664SC  
STAGER  
SS824SC, SS857SCT/SWT/XALT/XCET



IP 3-PIN SIGNAL CABLE(-40°C) ( X30003 )

BLACK, 2.5m,  
WITH 3-PIN MALE AND FEMALE CONNECTOR

## SUITABLE FOR:

TOURZ  
SS342C1WT/XCET, SS345C1WT/XCET,  
SS352XCET, SS358XCET



Y TYPE SIGNAL CABLE ( X30047 )

Y TYPE SIGNAL CABLE,  
3-PIN XLR, IP65, BLACK

## SUITABLE FOR:

STAGER  
SS857SCT/SWT/XALT/XCET



HANGING BRACKET-P ( 2440104143 )  
RD-LED325XWAT-031-B,  
ELECTROPHORESIS BLACK+MATTE BLACK  
SUITABLE FOR:  
STAGER  
SS809XCA, SS819XS, SS822XAL



HANGING BRACKET-P ( X10104 )  
RD-SS648-175-A, ANODIC BLACK

SUITABLE FOR:  
TOURZ  
SS350XCEM, SS353XCEM, SS357XLEM  
PLUTO  
SS636XCE, SS646XCE, SS656XAE/XCE  
SS657SC HD, SS658SC, SS659SC  
SS660SC, SS662SC, SS664SC



06A CLAMP (ALUMINUM) ( X50001 )  
AVAILABLE PIPE: 40-60MM  
MAX LOAD: 30KG  
115(L)\*80(W)MM  
SUITABLE FOR:  
PLUTO  
SS636XCE, SS646XCE, SS656XCE  
SS657SC HD, SS658SC, SS659SC  
SS660SC, SS661SC, SS662SC, SS663SC  
SS664SC  
CYAN  
SS631XCE, SS644XCE  
NEPTUNE  
SS671XCEM, SS673SCM, SS676SCM



CLAMP ( X50081 )  
AVAILABLE PIPE: 40-52mm  
MAX LOAD: 200KG  
SUITABLE FOR:  
PLUTO  
SS636XCE, SS646XCE, SS656XCE  
SS657SC HD, SS658SC, SS659SC  
SS660SC, SS661SC, SS662SC, SS663SC  
SS664SC  
CYAN  
SS631XCE, SS644XCE  
NEPTUNE  
SS671XCEM, SS673SCM, SS676SCM



CLAMP ( X50021 )  
MODEL: M0N0N-CLA0015A  
SUITABLE FOR:  
PLUTO  
SS636XCE, SS646XCE, SS656XCE  
SS657SC HD, SS658SC, SS659SC  
SS660SC, SS661SC, SS662SC, SS663SC  
SS664SC  
CYAN  
SS631XCE, SS644XCE  
NEPTUNE  
SS671XCEM, SS673SCM, SS676SCM



CLAMP ( X50093 )  
MODEL: CJS5005  
F34 Φ48-51MM  
MAX LOAD: 250kg  
SUITABLE FOR:  
PLUTO  
SS636XCE, SS646XCE, SS656XCE  
SS657SC HD, SS658SC, SS659SC  
SS660SC, SS661SC, SS662SC, SS663SC  
SS664SC  
CYAN  
SS631XCE, SS644XCE  
NEPTUNE  
SS671XCEM, SS673SCM, SS676SCM



SA106 ( SA106-00000-K000 )  
INDOOR, GRAY, 3-PIN XLR

USED FOR SOFTWARE UPLOAD  
①OFFLINE UPLOAD  
②VIA DMX SIGNAL

SUITABLE FOR:  
ALL FIXTURES OF YAJIANG



SA106 ( SA106-00000-K00A )  
INDOOR, GRAY, 5-PIN XLR

USED FOR SOFTWARE UPLOAD  
①OFFLINE UPLOAD  
②VIA DMX SIGNAL

SUITABLE FOR:  
ALL FIXTURES OF YAJIANG



700 ( AM700-00000-K000 )  
700 DMX ENCODER, INDOOR

SUITABLE FOR:  
STAGER  
SS817SW/SC, SS867SCD/SWD, SS868SW/SC  
SS868SWD/SCD



SAFETY BELT WITH LOCK ( 1340700002 )  
DIAMETER : 3.0mm,  
LENGTH: 1m,  
TENSION: 3.0kN  
SUITABLE FOR:  
ALL FIXTURES OF YAJIANG



BOTTOM CASE SAFETY BELT  
( 1340700004 )  
Φ6\*1200mm  
SUITABLE FOR:  
ALL FIXTURES OF YAJIANG



SAFETY BELT BUTTON ( 1340700006 )  
( N ) Φ7.8BOREΦ24  
SUITABLE FOR:  
ALL FIXTURES OF YAJIANG



LAMP COVER SAFETY BELT  
( 1340700008 )  
DIAMETER: 0.6mm, LENGTH: 50mm,  
TENSION: 0.13kN, CANN' T SNAP THE  
STEEL WIRE ON EACH END OF CIRCLE  
SUITABLE FOR:  
ALL FIXTURES OF YAJIANG



SAFETY BELT ( 1340700009 )  
DIAMETER: 1.6mm, LENGTH: 1.5m,  
TENSION: 1.5kN, SALTING TEST  
WITHOUT BLACK DOT.  
SUITABLE FOR:  
ALL FIXTURES OF YAJIANG



SAFETY BELT ( 1340700015 )  
DIAMETER: 1.6mm, LENGTH: 0.3m,  
TENSION: 1.5kN, SALTING TEST  
WITHOUT BLACK DOT  
SUITABLE FOR:  
ALL FIXTURES OF YAJIANG



SAFETY BELT ( 1340700018 )  
DIAMETER: 1.6mm, LENGTH: 0.7m,  
TENSION: 500-700N,  
SALTING TEST WITHOUT BLACK DOT  
(STAINLESS STEEL 304)  
SUITABLE FOR:  
ALL FIXTURES OF YAJIANG



SAFETY BELT ( 1340700019 )  
( N ) Φ7.8BOREΦ24  
( MATERIALS : STAINLESS STEEL 304 )  
SUITABLE FOR:  
ALL FIXTURES OF YAJIANG